

**False River  
Watershed Council**



**MANAGING  
FALSE RIVER  
WATERSHED  
RESOURCES**

*An Interim Report to the Louisiana Legislature*

*February 2018*

***To the Distinguished Members of the La. House Committee on Natural Resources and Environment and Senate Committee on Environmental Quality of the Louisiana Legislature and the People of the Great State of Louisiana***

February 12, 2018

Dear Members:

We, the members of the False River Watershed Council, have completed this updated report in accordance with House Concurrent Resolution No. 52 of Regular Session 2017. The original May, 2013 report was completed in accordance with House Concurrent Resolution No. 123 of Regular Session 2012.

Specifically, the False River Watershed Council has assembled and prepared this document which is a plan of action for watershed management. It is the intent of this Council, interested stakeholders, and all those involved in the project to preserve, protect, and enhance the quality of False River, located in Pointe Coupee Parish, now and for generations to come.

The report offers background information, an executive summary, graphs, charts and maps, and recommendations for your review. It includes the results of the completed False River Aquatic Resources Ecosystem Restoration Project - Phase I and the False River Nutrients Mitigation Project. We look forward to any further guidance or feedback as we press forward with the False River Aquatic Resources Ecosystem Restoration Project – Phase II.

We appreciate the support of the Louisiana Legislature as we move forward with this plan of action.

Sincerely yours,

***The Members of the False River Watershed Council***

## **False River Watershed Fact Sheet**

### **False River Watershed:**

- Pointe Coupee Parish
- Total area: ~35,000 acres
- Area of “The Island”: ~18,400 acres (53%)  
(defined herein as east of False River, South of False Bayou, north of the Chenal and west of the Mississippi River)
- Discharge Bayou drainage area (M-1 and associated canals): ~17,600 acres (50%)
- M-2 Canal and False Bayou drainage area: ~9,500 acres (27%)
- Cultivated area (2011): ~2,300 acres (7%)
- Developed area (2011): ~1,700 acres (5%)

### **False River (lake)**

- Owned by the State of Louisiana
- Oxbow/horseshoe lake – abandoned (~1722) meander of the Mississippi River
- Area: ~3,100 acres (3,200 acres with associated wetlands)
- Shoreline: 117,000 feet (22 miles)
- Developed shoreline: 110,000 feet (21 miles)
- Pool stage: 16 feet above mean sea level (NGVD)
- Volume (pool stage): 67,300 acre-feet (22 billion gallons)
- Maximum depth: 65 feet
- Average depth: 21 feet
- Highest water level recorded: 23.2 feet (1983)
- Lowest water level recorded: 10.6 feet (2016)
- Primary Outfall - Lighthouse Canal Structure maximum capacity: 1,400 cfs (three roller gates)
- Lighthouse Canal Structure owned by LDOTD and operated by PCPJ
- Secondary Outfall - Bayou Sere invert eight: 15 feet (outflow start at 16.5 ft).
- Estimated sediment influx (2011 - NRCS RUSLE2 model): 21,000 tons
- South Flats Island: 16.5 acres (3,500 feet of shoreline)

Sources: LDNR, 2012 & 2017; NRCS, 2011 & 2017; USGS, 1999; LDWF, 2011 & 2016; USACE, 2011

Note: Front cover picture of the South Flats Island courtesy of Delta Land Services, LLC.

**Members of the False River Watershed Council**

**Richard Moses - Chairman**

Director, Inland Fisheries Section  
Louisiana Department of Wildlife & Fisheries  
P.O. Box 98000, 2000 Quail Drive  
Baton Rouge, LA 70898  
Phone: (225) 765-2331/Email: [rmoses@wlf.la.gov](mailto:rmoses@wlf.la.gov)

**Thomas Van Biersel, PhD - Vice Chairman**

Senior Coastal Resources Scientist  
Louisiana Department of Natural Resources  
P.O. Box 44487, 617 North Third Street  
Baton Rouge, Louisiana 70804-4487  
Phone: (225) 342-1813/Email: [thomas.vanbiersel@LA.GOV](mailto:thomas.vanbiersel@LA.GOV)

**Arthur Ewing**

Appointed by the Pointe Coupee Parish Police Jury  
P.O. Box 290, New Roads, La. 70760  
Phone: (225) /Email: [aoewing@gmail.com](mailto:aoewing@gmail.com)

**Brad Spicer**

Assistant Commissioner, Soil and Water Conservation  
Louisiana Department of Agriculture and Forestry  
P.O. Box 631, 5825 Florida Blvd.  
Baton Rouge, LA 70821-0631  
Phone: (225) 922-1269/Email: [brad\\_s@ldaf.state.la.us](mailto:brad_s@ldaf.state.la.us)

**Byron Nagel, PE**

District 2 Engineer, Office of Public Health  
Louisiana Department of Health  
P. O. Box 629, 628 N. 4th Street  
Baton Rouge, LA 70821-0629  
Phone: (225) 342-7395/Email: [Byron.Nagel@la.gov](mailto:Byron.Nagel@la.gov)

**Jimmy Chustz, PLS**

Appointed by the representative from House District 18  
Chustz Surveying, Inc.  
211 Richy Street, New Roads, LA 70760  
Phone: (225) 638-5949/Email: [jchustz@chustz.com](mailto:jchustz@chustz.com)

**Cy Daquila**

Selected by the senator from Senate District 17  
P.O. Box 866, New Roads, LA 70760  
Phone: (225) 718-0506/Email: [Cjdr80@bellsouth.net](mailto:Cjdr80@bellsouth.net)

**Jerry Hix**

Appointed by the mayor of the city of New Roads  
Phone: (225) 618-8867/Email: [jdhix@aol.com](mailto:jdhix@aol.com)

**Mark Ward**

Director  
Pointe Coupee Parish Office of Emergency Preparedness  
P.O. Box 248, East Main Street  
New Roads, LA 70760  
Phone: (225) 638-5400/Email: [Mward@pcpsso.org](mailto:Mward@pcpsso.org)

**Stephen Chustz**

Appointed by the representative from House District 18  
Phone: (225) /Email: [chustz@msn.com](mailto:chustz@msn.com)

**Bijan Sharafkhani, PE**

Confidential Advisor to the Secretary  
Louisiana Department of Environmental Quality  
P.O. Box 4301  
Baton Rouge, LA 70821-4301  
Phone: (225) 219-3953/Email: [Bijan.Sharafkhani@la.gov](mailto:Bijan.Sharafkhani@la.gov)

**Kyle Olinde**

Juror - District 5  
Appointed by the Pointe Coupee Police Jury  
10961 Olinde Lane, Ventress, LA 70783  
(225) 618-9023/Email: [kolindepj5@gmail.com](mailto:kolindepj5@gmail.com)

**Ron Pourciau**

Selected by the senator from Senate District 17  
Phone: (225) 240-9892/Email: [ron@rwntf.com](mailto:ron@rwntf.com)

**Major Thibaut**

Representative – District 18  
2004 False River Drive  
New Roads, LA 70760  
Phone: (225) 638-3811/Email: [thibautm@legis.la.gov](mailto:thibautm@legis.la.gov)

**Rick Ward, III**

Senator – District 17  
3741 Highway 1  
Port Allen, LA 70767  
Phone: (225) 246-8838/Email: [wardr@legis.la.gov](mailto:wardr@legis.la.gov)

**Other Contributors to the Report**

Chris Knotts, PE  
Chief Engineer  
Louisiana Department of Transportation and Development  
P.O. Box 94245, 1201 Capital Access Rd.  
Baton Rouge, LA 70804-9245  
Office: (225) 379-3015/Email: [Chris.Knotts@LA.GOV](mailto:Chris.Knotts@LA.GOV)

Brian Heimann  
Biologist Manager, Inland Fisheries Section  
Louisiana Department of Wildlife & Fisheries  
P.O. Box 98000, 2000 Quail Drive  
Baton Rouge, LA 70898  
Phone: (225) 765-2337/Email: [bheimann@wlf.la.gov](mailto:bheimann@wlf.la.gov)

## **EXECUTIVE SUMMARY**

This document is an update of the report submitted to the legislature by the False River Watershed Council (FRWC) in response to House Concurrent Resolution No. 123 of the 2012 Louisiana Regular Session (HCR 123). HCR 123 established and mandated the FRWC to “meet as often as necessary to deliberate and produce a report that will identify, review, and evaluate management strategies to facilitate the goal of improving the aquatic habitat of False River; to provide recommendations for the optimal management and protection of the resources within the False River watershed, including, but not limited, to the following: the study of impacts and potential impacts to water quality, excess nutrient and sediment run-off management, shoreline modification management, watershed conservation measures, and innovative habitat restoration methodology; coordination of federal, state, and local efforts to improve and protect water quality; surface water resource management and protection policies; recommendations for the optimal management and protection of the natural resources in the False River watershed; identification of various funding options for ongoing maintenance of the False River watershed; recommended changes to current procedures and practices to make the management and protection of the natural resources in the False River watershed more efficient, comprehensive, and sustainable.” House Concurrent Resolution No. 52 of the 2017 Louisiana Regular Session (HCR 52) resolved that the FRWC prepare and submit another up-to-date report to the legislature, including the results of the actions taken in the past five years as part of the False River Aquatic Resources Ecosystem Restoration Project - Phase I and the False River Nitrogen Impact Mitigation Project. This revised report is due not later than thirty days prior to the convening of the 2018 Regular Session.

False River is an abandoned meander of the Mississippi River. The cut-off began prior to 1699, and was well established by 1719. False River was a “Trophy Lake” from 1991 until the status was rescinded in 1998, due to the overall decline in the bass population. Alterations which occurred primarily during the 1970s and 80s along this oxbow lake, and within this oxbow lake’s watershed, have resulted in deterioration of the water quality, aquatic vegetation and fisheries.

This report is a watershed management plan which addresses the changes that came about from the U.S. Soil Conservation Service’s Watershed Plan and Environmental Impact Statement for Watershed Protection, Flood Prevention, and Drainage, Bayou Grosse Tete Watershed, Pointe

Coupee Parish, Louisiana project that was completed in 1983. This report also addresses changes resulting from land development along the lake shore, and any residual effect that remains to this day. Furthermore, the plan identifies potential changes that may occur in the future through land development within the watershed and addresses those as well. This is a living document that should be periodically updated to address changes in conditions and to take advantage of scientific discoveries and new technologies.

This plan takes a multifaceted approach to address issues with the lake as well as within the watershed, including engineered, education, enticement and enforcement solutions. The plan draws from the expertise of many parish, state and federal agencies, including the Department of Natural Resources, the Department of Wildlife and Fisheries, the Department of Environmental Quality, the Department of Health and Hospitals, the Department of Agriculture and Forestry, U.S. Department of Agriculture's Natural Resources Conservation Service (formerly the Soil Conservation Service), as well as other local stakeholders. The plan also incorporated the findings and recommendations presented in a Feasibility Study previously performed by the U.S. Army Corps of Engineers. The first solution is to inform the public and parish officials to take a short and long term view of the maintenance of aquatic habitat and water quality of the lake. This requires the stakeholders to voluntarily maintain and/or modify their shoreline, bulkhead, sewerage system, land-use/farming practices and runoff in a manner consistent with best management practices. These common sense activities would be achieved through community information releases and outreach. The second solution would be to provide enticement to stakeholders not readily willing or able to make limited modifications to their property in the form of available material and other non-monetary assistance, and to assist landowners to take full advantage of programs supported by the state, the U.S. government and others. Furthermore, in order to maintain the lake stage in a more natural and proactive manner, pro-actively manage lake stage including both high and low levels in collaboration with the Department of Wildlife and Fisheries. Finally, to minimize future deterioration of the lake's shoreline, fisheries, aquatic habitat and water quality, a new ordinance is being enacted and enforced.

Many solutions presented herein are intended for small scale remedies, such as at the property level. However, at the larger watershed scale, remedies designed to address the alteration (e.g. drainage canals) previously performed by the U.S. Soil Conservation Service (SCS), such as an engineered



solution is needed. Recent hydromodifications of channels, canals and sediment traps, and the accumulation of loose sediment in the lake's flats were modeled/tested, designed and implemented. Hydromodification of the two principal drainage systems addressed the sediment and nutrient flux into the lake, and have begun to result in improved water quality and aquatic habitat and fisheries, and also assist in flood control/mitigation. Loose sediment accumulations are expected to continue to be consolidated by drawing down the lake's water level, thereby reducing turbidity. Finally, the sequestration of sediment in the South Flats Island and resulting shoreline aquatic habitat creation has already begun to benefit this portion of the lake. In 2018, the dredging of North Flats is expected to provide similar benefits to the northern portion of the lake.

The 2012 watershed management plan recommended that the use of a more natural fluctuation of the lake level would be beneficial over the long term. Drawdowns in 2014 (3' to allow for the construction of the South Flats Island), in 2015 (2.5' for control structure repairs), in 2016 (6.5' performed after the flood of 2016) and in 2017 (6.3' aborted due to the storm/flood of 2017) have shown early benefits. The Department of Wildlife and Fisheries has proposed a ten-year drawdown plan, using a 3-year increment (2020, 2023 and 2026). These drawdowns will need to be repeated and monitored in the long term by the agency and the parish authority. This will provide for the shoreline, island, boat launches and watershed drainage channels maintenance, by property owners and parish authority using best management practices.

The plan recommends the design and installation of measures and/or solutions for specific issues associated with the lake's hydrology, water quality and fisheries. Specific solutions include, but are not limited to, the following: artificial reefs to provide cover for sportfish; gravel spawning beds; aquatic and shoreline vegetation planting; hydromodification of drainage channels for sediment retention; a vegetation buffer/filter zone, a grassed bench, and other vegetative edge/riparian habitats to improve water quality; retarding surface water runoff and stream flow by drainage network modification for flood control; redesign and modification of bulkheads and piers for wave attenuation; continued stocking of sportfish; maintaining the commercial fishing season to harvest roughfish stock; and the enactment of ordinances to address future physical changes in the watershed. In addition, the plan also recommends long term monitoring of the lake's health and long term evaluation of progresses associated with the proposed mitigation efforts.

## TABLE OF CONTENTS

EXECUTIVE SUMMARY .....	vi
TABLE OF FIGURES.....	x
TABLE OF APPENDICES .....	xi
ACRONYMS .....	xii
1 Introduction.....	1
2 Identification of Historical, Current and Future Watershed Issues/Concerns .....	1
2.1 Flooding .....	6
2.2 Water Quality .....	9
2.2.1 <i>pH</i> .....	10
2.2.2 <i>Dissolved Oxygen</i> .....	10
2.2.3 <i>Fecal Coliform</i> .....	10
2.2.4 <i>Nutrients</i> .....	13
2.2.5 <i>Pesticides</i> .....	18
2.2.6. <i>Turbidity</i> .....	18
2.2.7. <i>Sedimentation</i> .....	19
2.2.8 <i>Temperature</i> .....	19
2.3 Fisheries .....	23
2.3.1 <i>Non-native Fish</i> .....	23
2.3.2 <i>Declining Stock</i> .....	24
2.4 Aquatic Habitat .....	25
2.4.1 <i>Loss of Edge Habitat</i> .....	25
2.4.2 <i>Loss of Submerged Aquatic Vegetation</i> .....	26
2.4.3 <i>Boat Wake</i> .....	27
2.5 Land Use Development.....	27
2.5.1 <i>Shoreline Development</i> .....	27
2.5.2 <i>Bulkheads</i> .....	30
2.5.3 <i>Piers, Boathouses and Boatlifts</i> .....	30
2.5.4 <i>Sewerage Systems</i> .....	30
2.5.5 <i>Drainage Systems</i> .....	30
3 Management Strategies .....	31
3.1 Flooding .....	31

3.1.1	<i>Lake Level Management</i> .....	31
3.2	Water quality.....	34
3.2.1	<i>Nutrient Run-off Management</i> .....	34
3.2.2	<i>Sediment Run-off Management</i> .....	35
3.2.3	<i>Private/Public Sanitary Effluent Management</i> .....	36
3.2.4	<i>Storm Flow Management</i> .....	37
3.2.5	<i>Shoreline Modification Management</i> .....	37
3.2.6	<i>Watershed Conservation Measures</i> .....	39
3.2.7	<i>Habitat Restoration</i> .....	40
3.2.8	<i>Fisheries Management</i> .....	41
3.2.9	<i>Coordination of Federal, State, and Local Efforts to Improve and Protect Water Quality; Surface Water Resource Management and Protection Policies</i> .....	42
3.2.10	<i>Education and Outreach</i> .....	43
4.	Funding Strategies.....	43
4.1	Capital Outlay for Ecosystem Restoration.....	43
4.2	False River Restoration Fund.....	43
4.3	Other Funding Opportunities.....	44
5	Recommendations.....	44
6	References.....	46

## TABLE OF FIGURES

Figure 1:	False River Watershed.....	2
Figure 2:	1947 photographs of the False River Outfall Channel.....	4
Figure 3:	False River lake stages.....	7
Figure 4:	Correlation between False River and Mississippi River stages.....	7
Figure 5:	False River hydrograph (average, minimum and maximum stage values).....	8
Figure 6:	Hydrograph of the Flood of August 2016.....	8
Figure 7:	False River sampling and gaging locations.....	9
Figure 8:	False River pH readings.....	11
Figure 9:	False River dissolved oxygen concentrations.....	11
Figure 10:	False River lake level.....	12
Figure 11:	False River fecal coliform concentration.....	12
Figure 12:	False River Nitrate + Nitrite concentration.....	14
Figure 13:	False River Total Kjeldahl Nitrogen concentration.....	14

Figure 14: False River Total Nitrogen concentration .....	15
Figure 15: False River Total Phosphorus concentrations .....	15
Figure 16: False River Chlorophyll-A concentrations.....	16
Figure 17: Location of data sondes on The Island drainage network .....	17
Figure 18: M-1 Canal study hydrograph .....	17
Figure 19: M-1 Canal study turbidity data .....	18
Figure 20: False River turbidity readings .....	20
Figure 21: False River Total Suspended Solids concentrations .....	20
Figure 22: M-1 Canal weirs and baffles. ....	21
Figure 23: M-2 Canal weirs and baffles. ....	22
Figure 24: False River water temperature readings .....	23
Figure 25: Common carp CPUE from gillnet samples on FR (1990 to 2016) .....	24
Figure 26: CPUE values for largemouth bass on FR (1989 to 2017) .....	25
Figure 27: North Flats water depth.....	28
Figure 28: South Flats water depth.....	28
Figure 29: South Flats Island nearing completion. ....	29
Figure 30: Exposed sediments during the 2000 drought. ....	32
Figure 31: South Flats sediments exposed during the 2014 drawdown. ....	32
Figure 32: Hydrograph comparison of the August 2016 and October 2017 storm events. ....	33
Figure 33: North Flats sediments exposed during the 2016 drawdown. ....	33
Figure 34: Examples of shoreline mitigation treatments .....	38
Figure 35: Locations of gravel spawning beds placed in False River .....	40
Figure 36: Species, number and size of fish stocked by LDWF in False River since 2012. ....	42

## **TABLE OF APPENDICES**

Appendix A	Watershed Modeling Report
Appendix B	Shoreline Protection Information Flyer
Appendix C	Shoreline Ordinance
Appendix D	Water Quality Best Management Practices
Appendix E	Commodity Manual Best Management Practices

## ACRONYMS

ABP	Atchafalaya Basin Program (LDNR)
BMP	Best Management Practice
CPUE	Spring catch-per-unit-effort
EQIP	NRCS' Environmental Quality Incentives Program
FRWC	False River Watershed Council
GEC	Gulf Engineers & Consultants, Inc.
HCR	House Concurrent Resolution
LDAF	Louisiana Department of Agriculture and Forestry
LDEQ	Louisiana Department of Environmental Quality
LDHH	Louisiana Department of Health and Hospitals
LDNR	Louisiana Department of Natural Resources
LDOTD	Louisiana Department of Transportation and Development
LDWF	Louisiana Department of Wildlife and Fisheries
MSL	Mean sea level
NRCS	Natural Resources Conservation Service
PCPJ	Pointe Coupee Police Jury
NTU	Nephelometric turbidity units
NPS	Nonpoint Source Program
SCS	Soil Conservation Service (U.S.)
SWCD	Soil and Water Conservation Districts
TSS	Total Suspended Solids
USACE	United States Army Corps of Engineers
USEPA	United States Environmental Protection Agency
USDA	United States Department of Agriculture

## **1 Introduction**

The False River Watershed Council (FRWC) was created in response to House Concurrent Resolution No. 123 of the 2012 Louisiana Regular Session (HCR 123). One of the mandate of HCR 123 of 2012 was that the FRWC

*“ . . . produce a report that will identify, review, and evaluate management strategies to facilitate the goal of improving the aquatic habitat of False River; to provide recommendations for the optimal management and protection of the resources within the False River watershed, including but not limited to the following: the study of impacts and potential impacts to water quality, excess nutrient and sediment run-off management, shoreline modification management, watershed conservation measures, and innovative habitat restoration methodology; coordination of federal, state, and local efforts to improve and protect water quality; surface water resource management and protection policies; recommendations for the optimal management and protection of the natural resources in the False River watershed; identification of various funding options for ongoing maintenance of the False River watershed; recommended changes to current procedures and practices to make the management and protection of the natural resources in the False River watershed more efficient, comprehensive, and sustainable.”*

The report was submitted to the House Committee on Natural Resources and Environment and the Senate Committee on Environmental Quality on May 1, 2013. The existence of the FRWC was extended by HCR 230 of 2015 until June 20, 2016, by HCR 36 of 2016 until June 30, 2017, and by HCR 52 of 2017 until January 13, 2020. In Addition, HCR 52 of 2017 requested that the FRWC

*“submit a report to the legislature no later than thirty days prior to the convening of the 2018 Regular Session.”*

## **2 Identification of Historical, Current and Future Watershed Issues/Concerns**

False River is an abandoned meander of the Mississippi River (Figure 1). The cut-off began prior to 1699, and was well established by 1719. Alterations along this oxbow lake and within this oxbow lake’s watershed have resulted in deterioration of the water quality, aquatic vegetation and fisheries. The extent of the False River watershed is shown on Figure 1.



Figure 1: False River Watershed

Based upon a rapid survey of available information, the following timeline can be established:

- 1947 the False River Outfall Channel (FROC - a.k.a. Lighthouse Canal – see Figure 2) is built as an additional outlet for the lake.
- 1948 The False River drainage control structure on the FROC (Figure 1) is built to control the lake stage. The weir has a fixed elevation of 15.0 feet above mean sea level (MSL) with a maximum height of 20.96 ft. NGVD with stop logs. Approximately 12,000 acres (71%) of The Island is not being used for agricultural purposes.
- 1969 U.S. Department of Agriculture’s (USDA) Soil Conservation Service’s (SCS) Bayou Grosse Tete Watershed study and the design survey for the M-1 Canal (a.k.a. Discharge Bayou) are started.
- 1973 Most of the land enclosed in the oxbow lake (a.k.a. The Island) is cleared and drained, and was being converted to soy bean cultivation.
- 1976 Bayou Grosse Tete Watershed study is completed, a report entitled “Watershed Plan and Environmental Impact Statement for Watershed Protection, Flood Prevention, and Drainage, Bayou Grosse Tete Watershed, Pointe Coupee Parish, Louisiana” is published, and the work plan approved by the U.S. Congress.
- 1977 U.S. Environmental Protection Agency (USEPA) describes the lake as eutrophic with severely low dissolved oxygen levels in the summer.
- 1981 USDA’s Soil Conservation Service (SCS) completes installation of the M-1 Canal and the associated sediment basin, and the M-2 Canal (Figure 1). As-built drawings of the M-1 canal and its sediment basin are drafted.
- 1983 Bayou Grosse Tete Watershed Project is completed. Only ~5,000 acres (28%) of The Island remains un-cultivated.
- 1980s Peak crop production occurs on The Island. Approximately 75% of The Island is under agricultural use.
- 1989 Louisiana Department of Transportation and Development (LDOTD) replaces the stop-logs with three 5x8 feet (ft.) sluice gates with invert elevation of 10 ft.
- 1999 PCPJ excavates a large amount of silt (>10,000 cubic yards) from the sediment basin.
- 1993 LDOTD approves an increase in pool level from 15 to 16 ft. MSL for part of the year.
- 1998 U.S. Geological Survey (USGS) performs a bathymetry survey of the lake.
- 2000 A regional drought naturally bring the lake level to 13.7 ft NGVD (12.5 ft NAVD)
- 2001 USACE proposes the False River Aquatic Ecosystem Restoration Study.
- 2003 USACE estimates that 28,000 tons of silt is being deposited into False River annually.
- 2005 USDA’s Natural Resources Conservation Service (NRCS , formerly SCS) surveys the M-1 Canal sediment basin and installs fencing along parts of the M-1 Canal.
- 2006 PCPJ excavates approximately 8,000 to 10,000 cubic yards of silt from the M-1 Canal sediment basin.
- 2010 PCPJ excavates 1,200-1,500 cubic yards of silt from the M-1 Canal sediment basin.
- 2010 Louisiana Department of Wildlife and Fisheries (LDWF) proposes a fall/winter drawdown of the lake to 10’ MSL.





Figure 2: 1947 photographs of the False River Outfall Channel  
(SOURCES: Courtesy of Jens Rummler and the Succession of Mrs. Floerl Martin Christie Rougon)

- 2011 Plans for a drawdown are called off.
- 2011 NRCS estimates that approximately 21,000 tons of sediment is being lost to erosion from crop and pasture land in the False River watershed.
- 2011 The Louisiana Legislature requests the involvement of LDNR, in conjunction with the PCPJ, to assume the lead project sponsorship for the False River Aquatic Resources Ecosystem Restoration Project.
- 2011 LDNR meets with Representative Thibaut, author of HCR No. 168, and with representatives of the PCPJ, the LDWF, the USACE, and its contractor and NRCS to discuss the status of the project.
- 2012 In accordance with HCR-168 of 2011, LDNR prepares a report suggesting a local approach to implementing several tasks of False River Aquatic Resources Ecosystem Restoration Project.
- 2012 The FRWC is established under HCR-123 of 2012 and is mandated to prepare by May 2013 a watershed management plan for False River.
- 2013 The FRWC issues a watershed management plan to the Louisiana Legislature.
- 2014 The lake level is lowered approximately 2.5 foot, mimicking the drought of 2000 and allowing for the construction of the retaining levee of the South Flats Island.
- 2015 Start of the Nitrogen Mitigation Project funded by Louisiana Generating LLC. The project seeks to address the ongoing nutrients (and sediment fluxes) into the lake.
- 2015 HCR 230 of 2015 extends the FRWC until June 20, 2016.
- 2015 Completion of the False River Ecosystem Restoration Phase I. A 16.5 acres island was built in the South Flats using 42 acres of dredge material. The island created 3,500 feet of edge habitat and sequestered 159,700 cubic yards of sediment.
- 2016 HCR 36 of 2016 extends the FRWC until June 30, 2017.
- 2016 Phase II of the False River Ecosystem Restoration project begins with a magnetometer survey of the North Flats and an evaluation of disposal alternatives for those sediments.
- 2016 During the August floods the highest lake level, 22 feet NGVD (20.8 ft NAVD), was recorded (Figure 3).
- 2017 LDWF begins the lake drawdown delayed by the flood; lake levels reach 9.4 ft (12.1 ft NAVD) by November 28.
- 2017 HCR 52 of 2017 extends the FRWC until January 13, 2020 and mandates that a revised watershed management plan be prepared by February 2018.
- 2017 LDWF begins a lake drawdown after Labor Day; lake levels reach 9.7 ft (12.1 ft NAVD) by October 16. The extreme rain event of October 21-22 (locally app. 15 inches of rain) raised the lake level 6.7 ft in three days. Due to the limited time remaining to achieve the goals of the drawdown, LDWF cancelled the event.
- 2017 Completion of hydromodifications included in the Nutrients Mitigation Project funded by Louisiana Generating LLC.
- 2017 FRWC proposed a shoreline protection ordinance to the Police Jury.
- 2018 FRWC issues a revised watershed management plan to the Louisiana Legislature.

## 2.1 Flooding

Since June 1965, the lake stage has been collected from several staff gage including one located at the Lighthouse Canal structure (Figure 3). High spring and low fall waters levels in False River can be correlated with those of the Mississippi River (USACE Red River Landing gage), indicating that a remnant of hydraulic connection exists between the two systems, most likely through the Mississippi River Alluvial Aquifer (Figure 4). Similarly, a typical hydrograph shows high water periods in the spring and low water periods in the fall (Figure 5). The annual pattern contributes to productivity of the lake's fisheries. High spring water coincides with most sport fish spawning periods and covers areas that stay dry throughout most of the year. The newly-flooded substrate is ideal spawning substrate for nesting sport fish. Flooded terrestrial vegetation provides protection for newly-hatched fish. Without exception, increased sport fish recruitment is linked to timely high water of sufficient duration. Low water levels in the fall expose bottom sediments to the sun and atmosphere. In addition to beneficial soil compaction, a drying period reduces organic material that could otherwise negatively impact spawning success.

The development of the False River shoreline is associated with demands to control water fluctuation and maintain a stable water level to the extent possible. The resulting user group conflict has been the source of considerable debate for an extended period of time. Currently the PCPJ makes efforts to accommodate its constituents and manipulates the False River water level toward a stable level. Flood control is conducted to the extent possible. A local association has recommended that the lake be lowered at a rate of 6 inches per day to 13' MSL if a six-inch rain is forecasted within a 6 to 10 day period. Under normal operating procedures the PCPJ has indicated that they can lower the lake 0.2 feet per day.

In 2012, an engineering firm, under contract by the LDNR began collecting hydrologic data along Discharge Bayou, including the M-1 Canal and its tributaries, the Chenal, the M-2 Canal and its tributaries and False Bayou (Figure 1) to assess the hydrologic response of this portion of the watershed to storm events and model the current hydrologic conditions on The Island. The model was used to evaluate potential hydromodifications along the drainage canals and bayous to delay peak flow and increase storage capacity. A second phase of the data collection and modeling including the M-2 Canal and its tributaries and False Bayou began in 2015 and is ongoing with post construction monitoring. The draft report prepared by the engineering firm is included in Appendix A.

In August 2016, Southeastern Louisiana experienced a storm event that precipitated within 24-hours span up to 32 inches of rain in places. For two days prior to the storm the PCPJ lowered the lake level in anticipation of the storm (Figure 6). The event showed lake levels rising from a stage of 15.2 ft NGVD (14.0 ft NAVD) to a crest of 22 feet NGVD (20.8 ft NAVD) in the span of five days and it required 24 days for the lake to return to pool stage (16 ft NGVD) with all three gates open and discharge occurring from the Bayou Sere outfall as well (occurs naturally above approximately 16.5 ft NGVD).

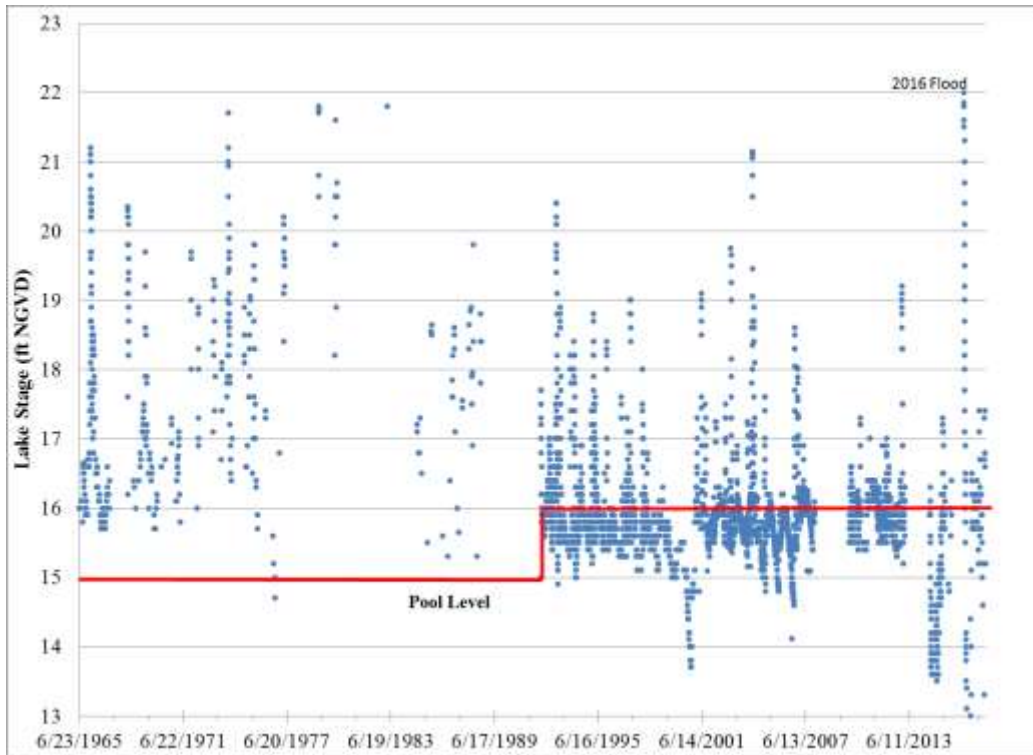

Figure 3: False River lake stages

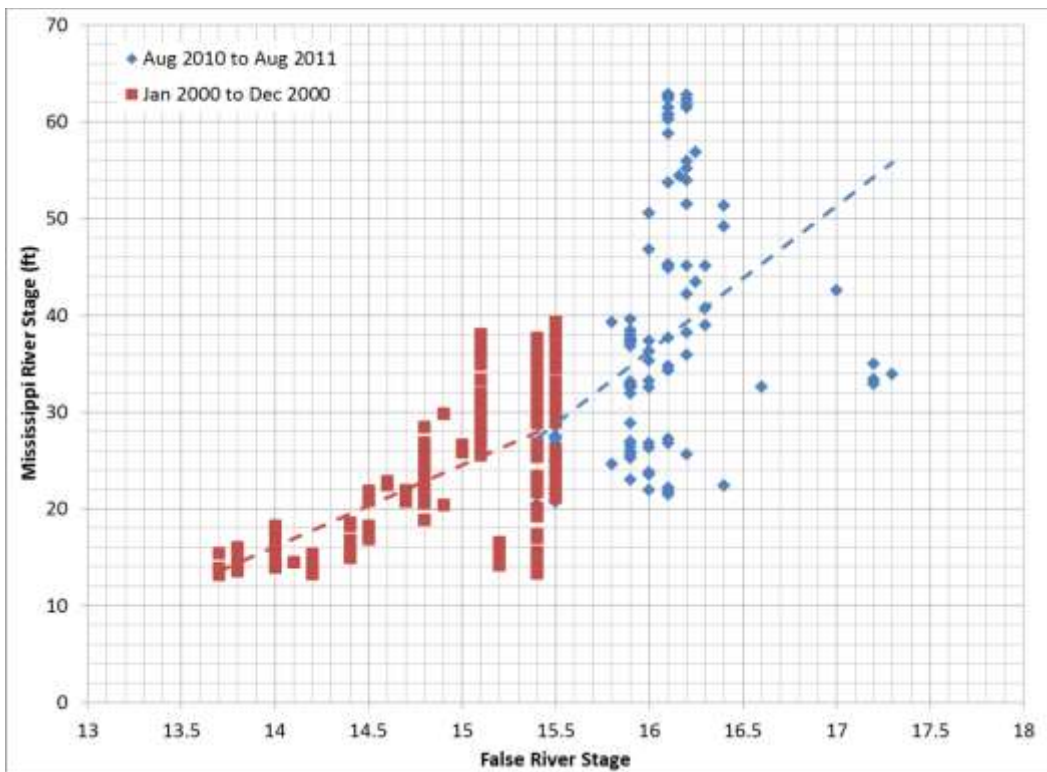

Figure 4: Correlation between False River and Mississippi River stages.

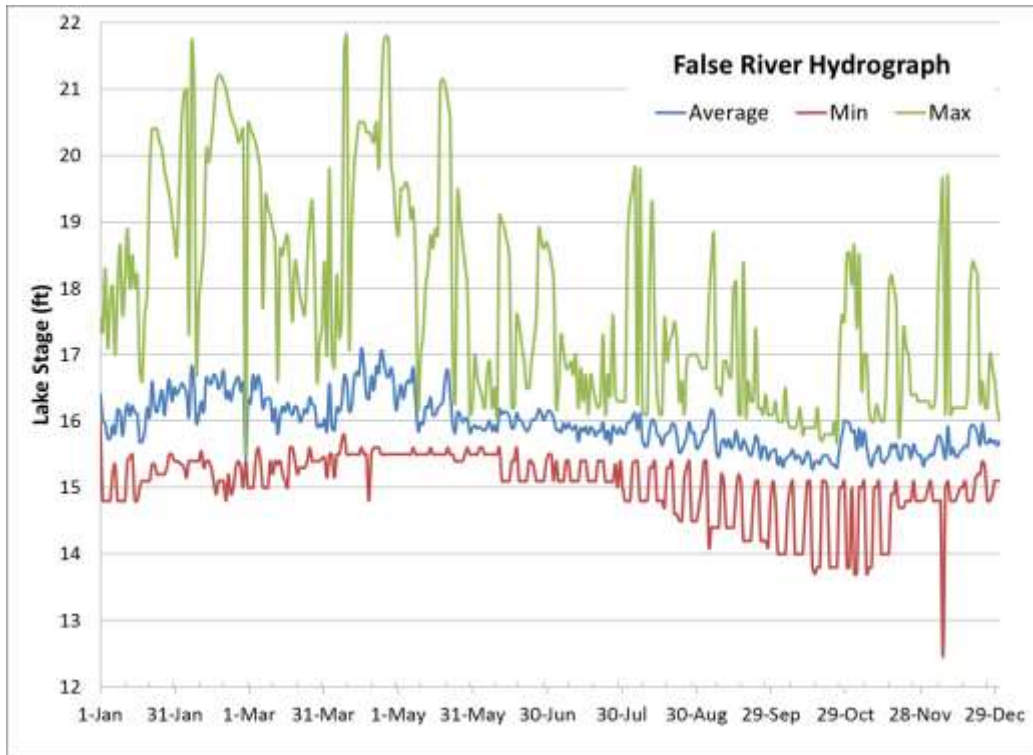

Figure 5: False River hydrograph (average, minimum and maximum stage values).

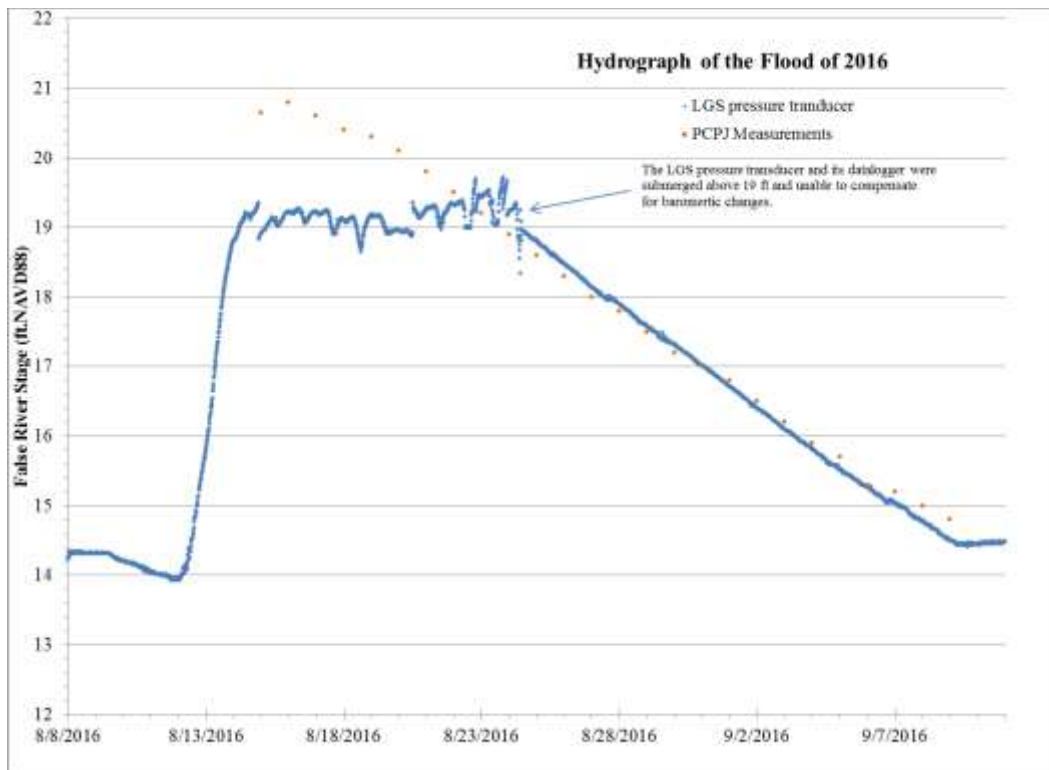

Figure 6: Hydrograph of the Flood of August 2016.

## 2.2 Water Quality

Water quality samples have been collected by various state and federal agencies or their contractor since November 18, 1963. There are over 90 locations within the watershed where water quality and sediment samples were collected (Figure 7). Over 27,000 readings and/or analyses were performed on water samples, and over 620 on sediment samples. In addition, over 44 fish tissue analyses are also available. This data was compiled by the LDNR into a database and used to prepare this report. Water sampling is ongoing by the LDEQ as part of routine ambient monitoring and by the engineering firm as part of the Nitrogen Impact Mitigation Project.

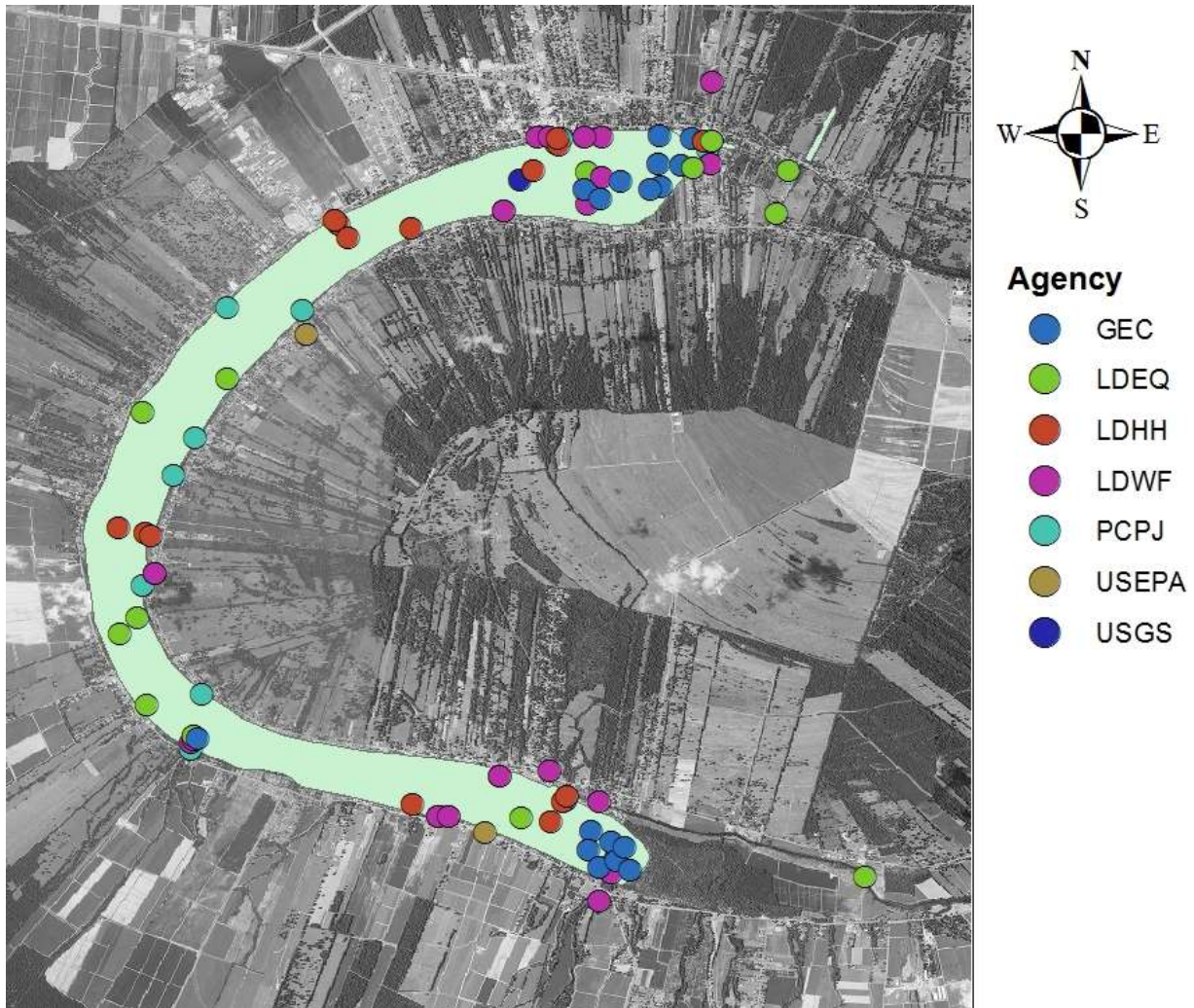

Figure 7: False River sampling and gaging locations

### **2.2.1 pH**

The data collected suggests that the pH of False River is showing to be stable over the last 50 years (Figure 8), although in the recent past several values have shown to be low (<6 s.u.). LDEQ's numerical criteria for pH in False River is between 6.0-8.5 s.u. It is expected that the observed seasonal variability in pH values is due to the similar increase in water temperature and nutrient loading of the lake.

### **2.2.2 Dissolved Oxygen**

The data collected suggests that dissolved oxygen concentrations in False River have been declining over the record period (Figure 9), although the highest recorded values were observed during November 2016, which coincide with the lowest lake levels recorded during the Fall drawdown that year (Figure 10). This overall decline can be partially attributed to poor water clarity, resulting in less sunlight reaching deeper into the lake's water. Sunlight fosters the growth of aquatic vegetation, and, therefore, photosynthesis and oxygen production. Without the presence of continuous water flow, False River is subject to annual stratification, a condition common to aquatic ecosystems. During the warm months of the year, stratification forms due to the effects of sunlight. The upper layer is warmer and less dense. The thickness of this upper layer is directly related to water clarity. In clear water, sunlight penetrates more deeply than in turbid water. Because sunlight is a requirement for oxygen production through photosynthesis, this upper layer is the region of highest dissolved oxygen. Water below the upper layer receives little sunlight, and, therefore, is colder and denser. This deeper layer has no incoming oxygen, and typically has very low dissolved oxygen. False River stratifies annually, and develops a 5 to 6-foot upper layer. Because the average depth of False River is 21 feet, aquatic life that requires oxygen is limited to the relatively small portion of the waterbody during the warm months of the year. LDEQ's numerical criteria for dissolved oxygen in False River is 3.3 mg/L (April-Sept.) and 5.0 mg/L (Oct.-Mar.). False River values seasonally dip below those criteria.

### **2.2.3 Fecal Coliform**

In the late 1990s and early 2000s, the PCPJ investigated the source of elevated fecal coliform counts measured in the lake's water (Figure 11). The PCPJ and other stakeholders remedied the sources identified by repairing and extending sewers. As shown on Figure 11, fecal coliform exceedences (primary standard: >400 col/100 mL and secondary standard: >2,000 col/100mL) were more common prior to 2004, and have not been observed since. Overall, fecal coliform counts in lake water have been declining during the period of record.

The Louisiana Department of Health (LDH – formerly Louisiana Department of Health and Hospitals) is requiring an update of individual waste treatment systems when a property transfer

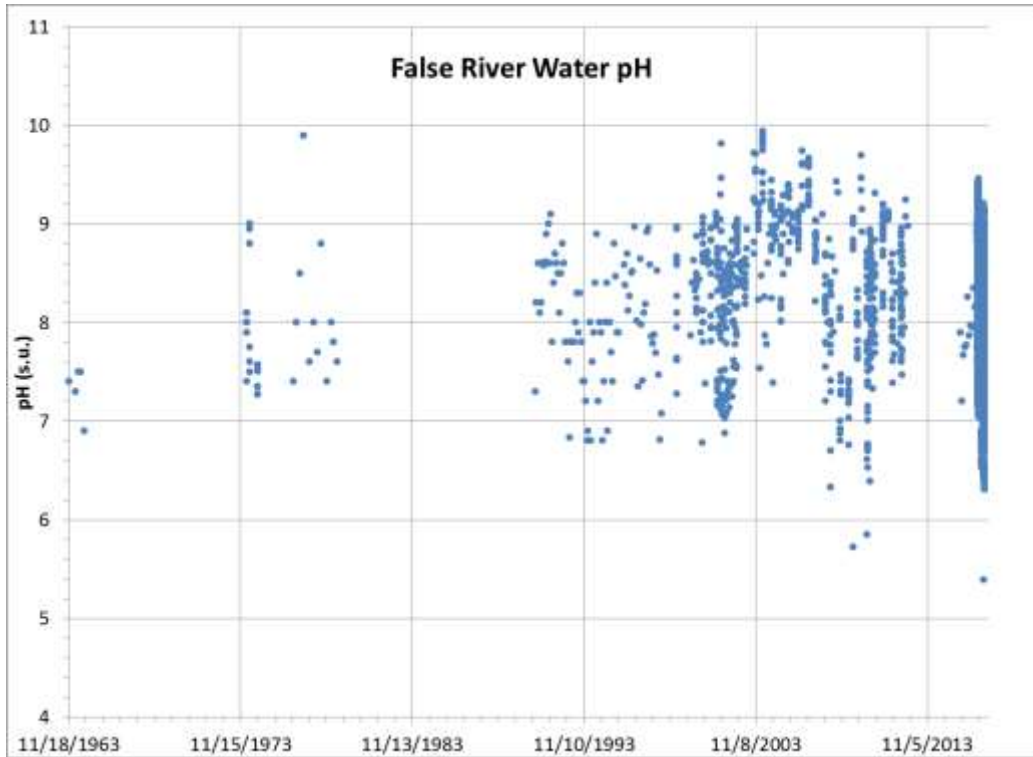

Figure 8: False River pH readings

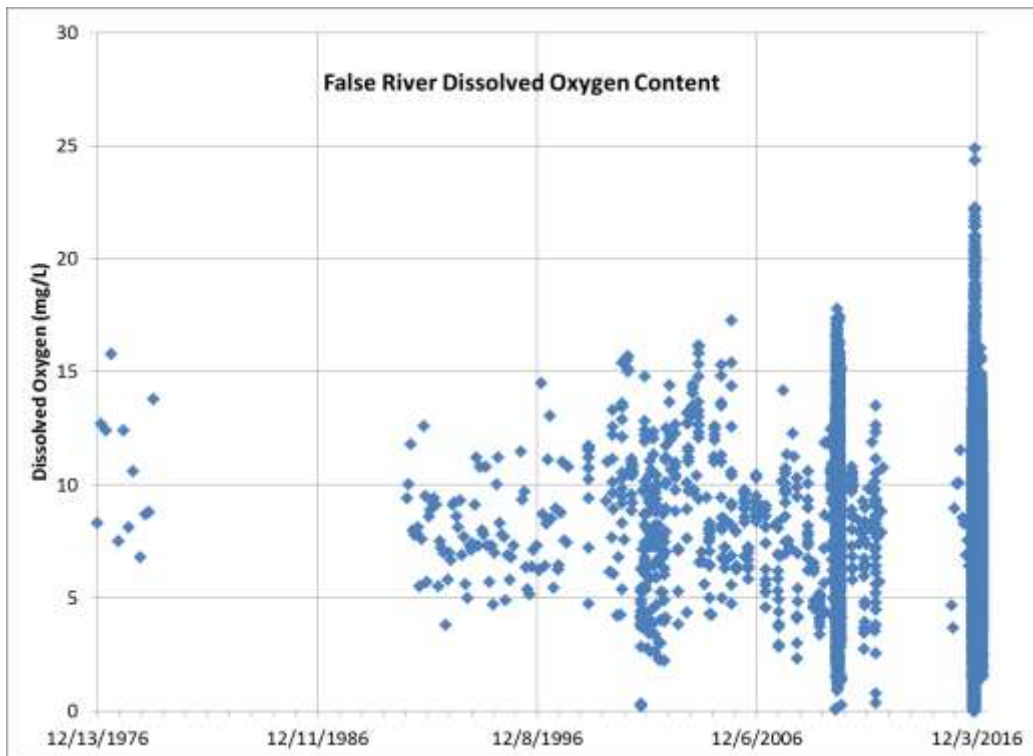

Figure 9: False River dissolved oxygen concentrations



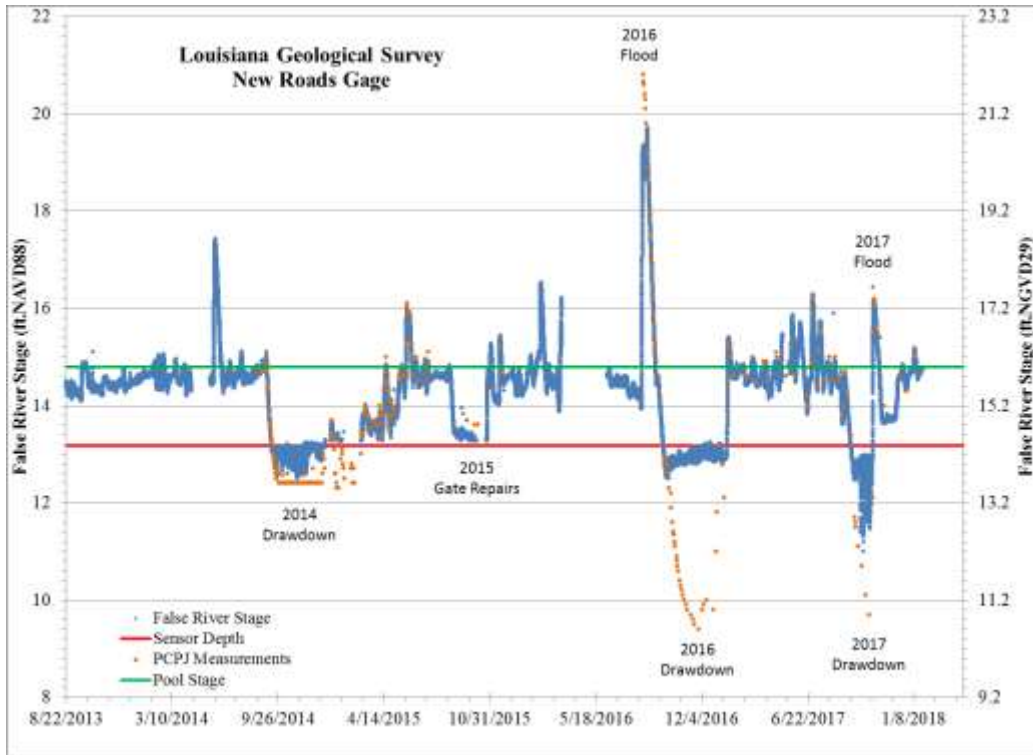

Figure 10: False River lake level

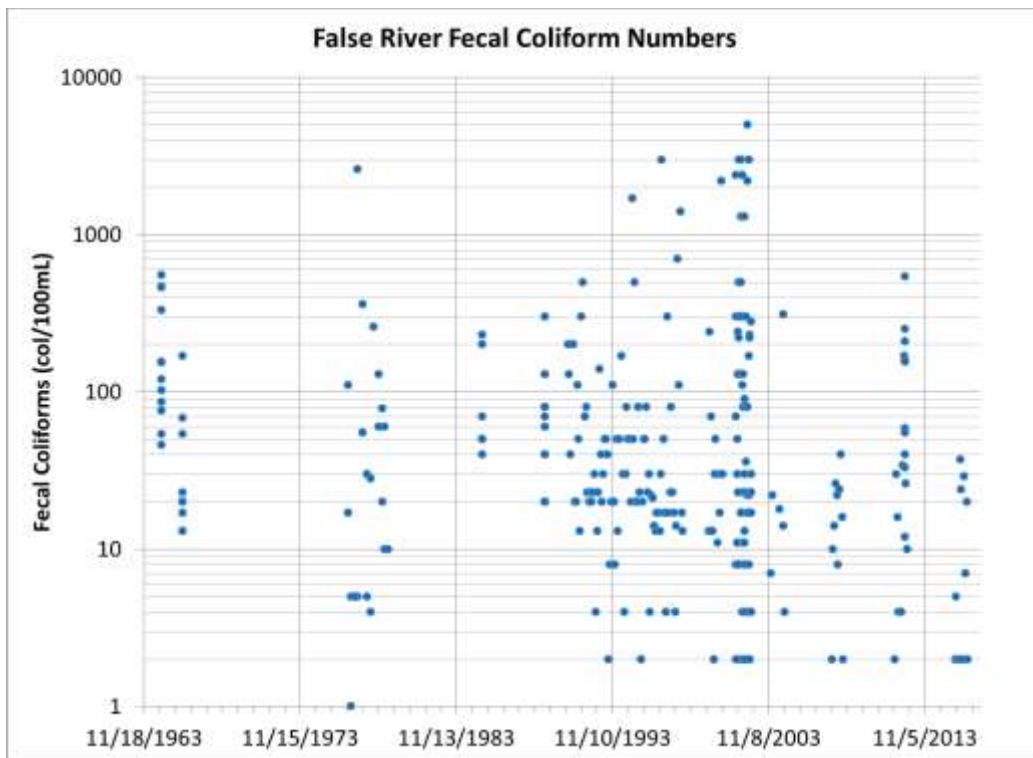

Figure 11: False River fecal coliform concentration

occurs. Furthermore, recently the PCPJ has made an application to LDH to finance the expansion of sewer service around the entire lake.

PCPJ has submitted a grant application to LDEQ for the evaluation of a sanitary sewer system for The Island. The FRWC, in collaboration with LDNR and LDH is making information on the LDNR's website available, regarding when new individual sewer systems are required and best management practices for existing individual waste water treatment systems. Information obtained to date has been placed on the LDNR website.

#### **2.2.4 Nutrients**

Since 1963, for False River the nutrient concentrations availability has been sporadic. Inorganic nutrients (Nitrate + Nitrite as N) have consistently ranged between below detection limit and at/or slightly above 1 mg/L (Figure 12). Organic nutrients [Total Kjeldahl Nitrogen (TKN)] have consistently ranged between below detection limit, and at or slightly above 2 mg/L, with the exception of one sample collected in 2000, one in 2002 and three following the flood of 2016 (Figure 13). One sample collected by LDEQ on 8/1/2000 reported a concentration of 57.6 ppm in the lake south of New Roads. Similarly, on 9/24/2002 an elevated data point (13.9 mg/L) was reported for False Bayou @ Hwy 413. These appear to be outliers when considering that during the flood of August 2016 the highest TKN value reported was 5.7 mg/L. Total Inorganic Nutrient (Nitrate + Nitrite as N plus Ammonia Nitrogen) ranged between below detection limit and 1 mg/L (Figure 14). This data is only available for 1974 and 1979. Total Nitrogen (calculated as Nitrate + Nitrite as N plus Total Kjeldahl Nitrogen) ranged between below detection limit and 57.6 mg/L N. Total Phosphorus ranged between 0 and 0.9 mg/L, except for one sample in 2002 with a concentration of 1.5 mg/L, one in 2000 with a concentration of 24.4 mg/L, and another in 2004 with a concentration of 519 mg/L (Figure 15). The Phosphorus concentration in the lake appears to have decreasing trend overtime. There are no specific standards for nutrients in surface water. Using a criteria of 1.27 mg/L for Total N and 0.05 mg/L for Total P, we can see that False River would be regularly above the Total Nitrogen and Total Phosphorus, as well as Chlorophyll-A criteria. Two-thirds (67%) of the recent Chlorophyll-A (Figure 16) data from False River exceeded 30 mg/L. This is the threshold between eutrophic and hyper-eutrophic, according to the National Lakes Assessment (USEPA, 2009).

Review of this information by LDEQ showed that these observations are consistent with their findings, reported in LDEQ's January 8, 2003 report. Total Phosphorus concentrations of unpolluted waters are reported to be usually less than 0.1 mg/L (Lind, 1979). Reid and Wood (1976) state that the mean total phosphorus content of most lakes ranges from 0.010 to 0.030 mg/L. Approximately two-thirds of recent Total Phosphorus data from False River reported exceeds the 0.1 mg/L value reported in the Common Methods citation above. In addition, data reported by LDEQ in 2003 indicate Total Phosphorus values approximately ten times the values reported by Reid and Wood (1976) as average lake values.

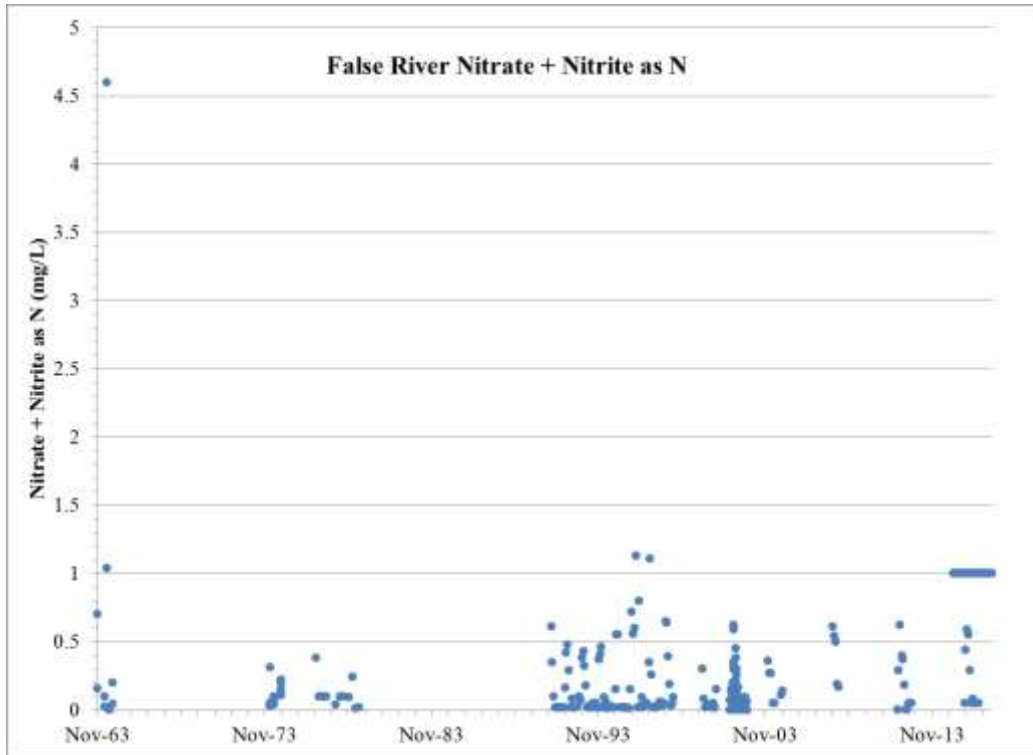

Figure 12: False River Nitrate + Nitrite concentration

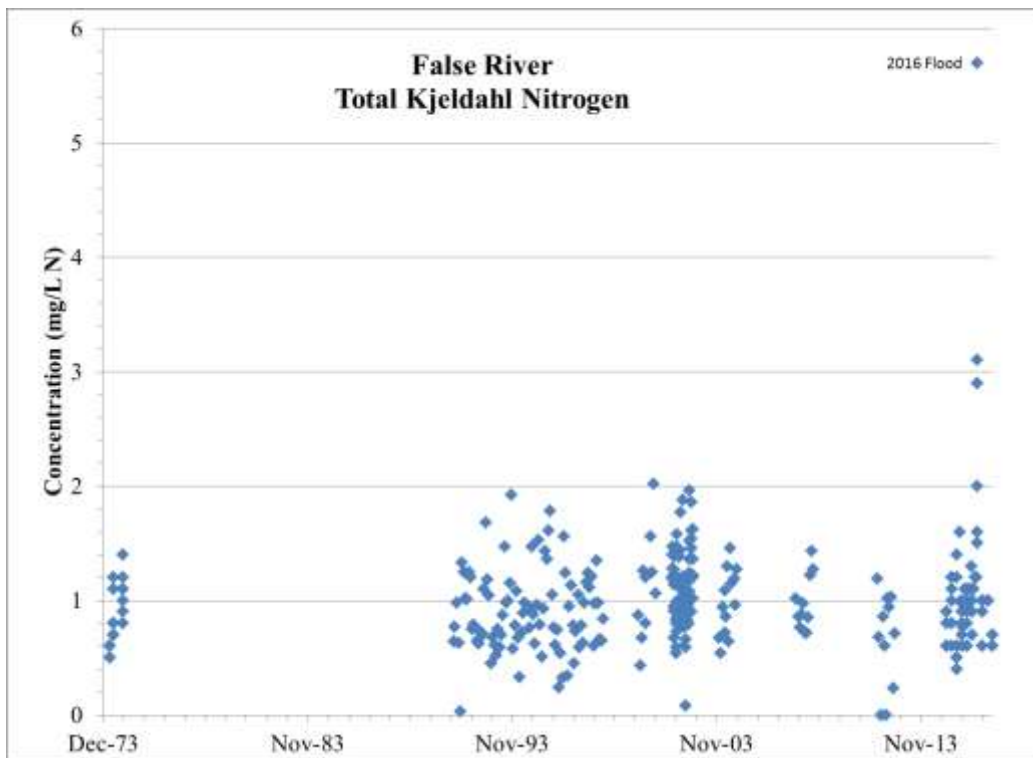

Figure 13: False River Total Kjeldahl Nitrogen concentration

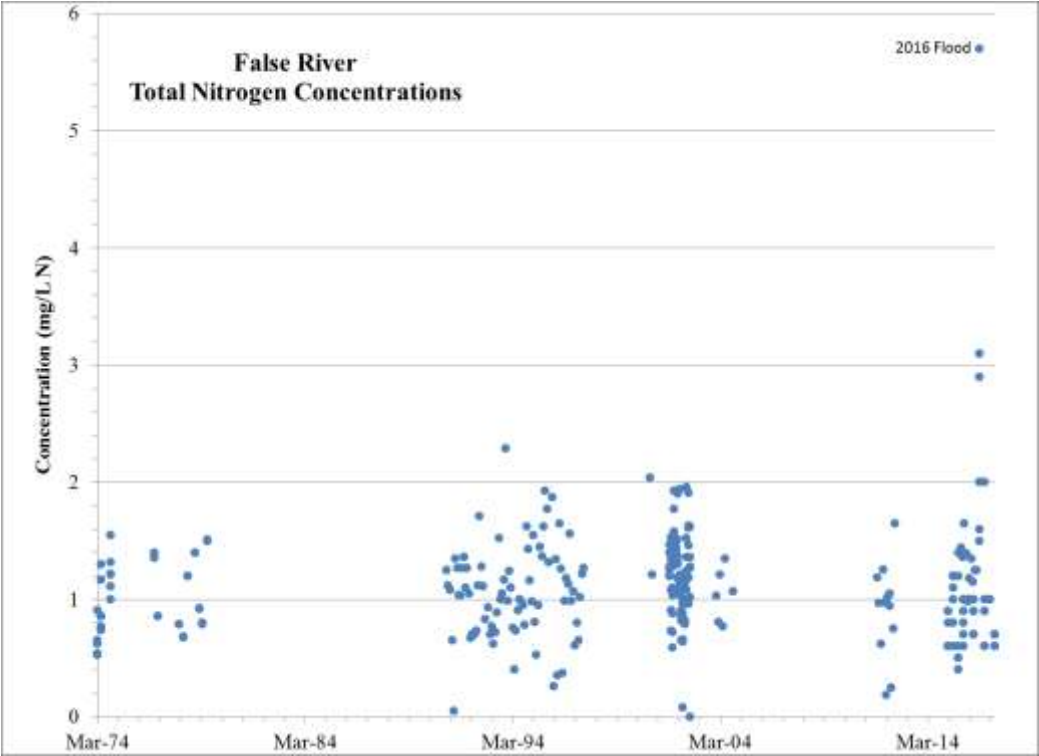

Figure 14: False River Total Nitrogen concentration

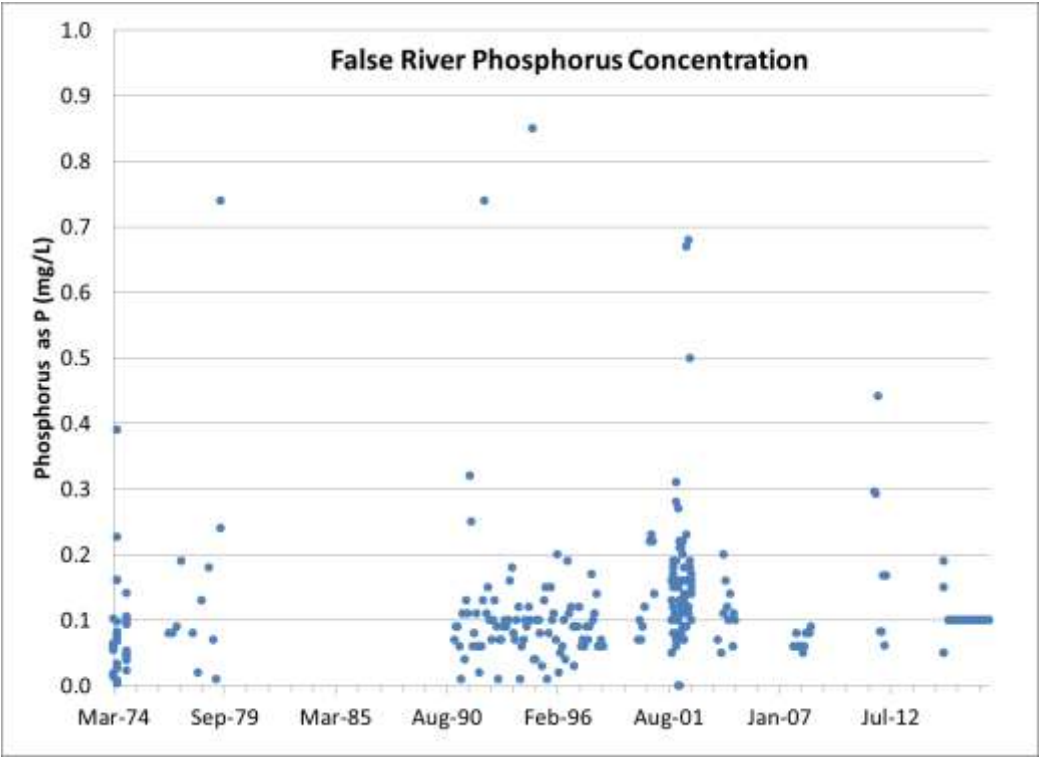

Figure 15: False River Total Phosphorus concentrations

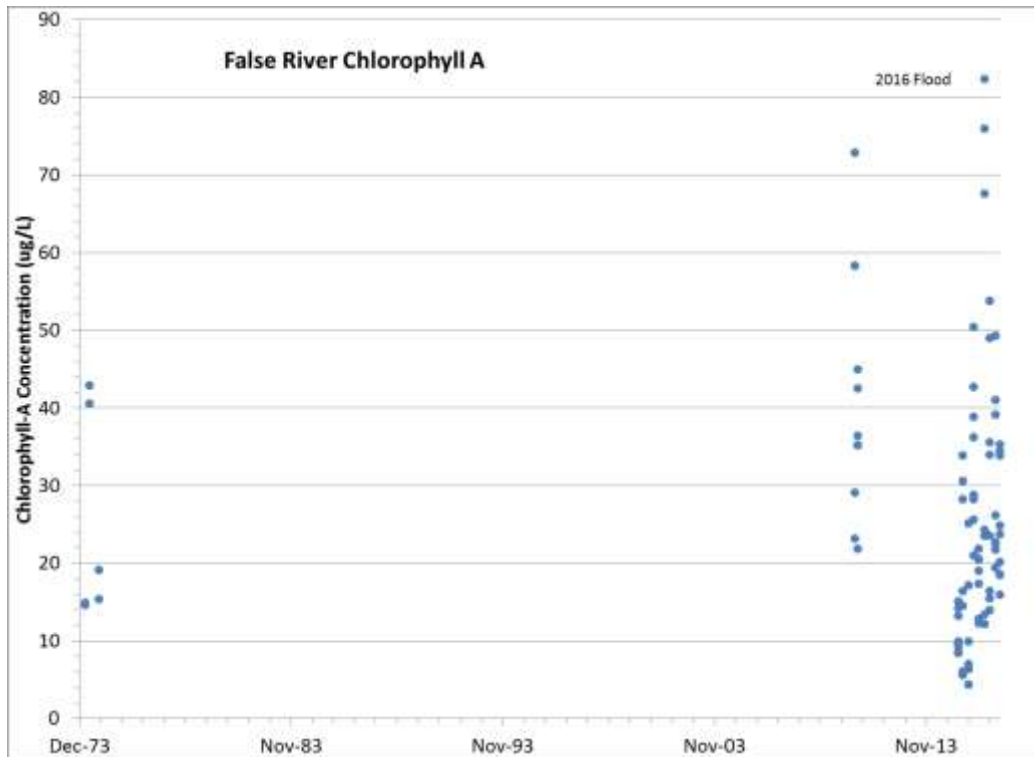

Figure 16: False River Chlorophyll-A concentrations

Nitrate concentrations vary widely across the U.S. However, in 2010 the National Atmospheric Deposition Program reported that average annual nitrate concentrations in rainfall in Louisiana were 0.4-0.5 mg/L. Approximately one-third of data exceeds that found in rainfall. While nitrogen concentrations may not frequently exceed rainfall values, it does appear that nitrogen compounds are present in sufficient quantities so as not to be limiting to aquatic plant growth.

False River Lake appears to be experiencing organic enrichment. That conclusion is supported by frequent anecdotal observations of significant algal populations, as evidenced by the frequent visible “pea-green” color of the lake water, and the elevated Chlorophyll-A values discussed above.

Funded first by the LDNR and then consequently by Louisiana Generating LLC, in late 2012, Fenstermaker & Associates LLC began an hydrologic study of the watershed. First, the consultants placed data gathering equipment in the M-1 Canal and the Chenal to determine the hydrology of this portion of the watershed and the current level of sediment flux into the South Flats (Figure 17). A local surveyor surveyed the channels profile and the data sonde housings. Six months of continuous data was collected, and used to model the hydrologic conditions on The Island. Data was continuously being downloaded and processed (Figures 18 and 19). Local residents assisted Fenstermaker & Associates LLC staff, by collecting time sensitive water

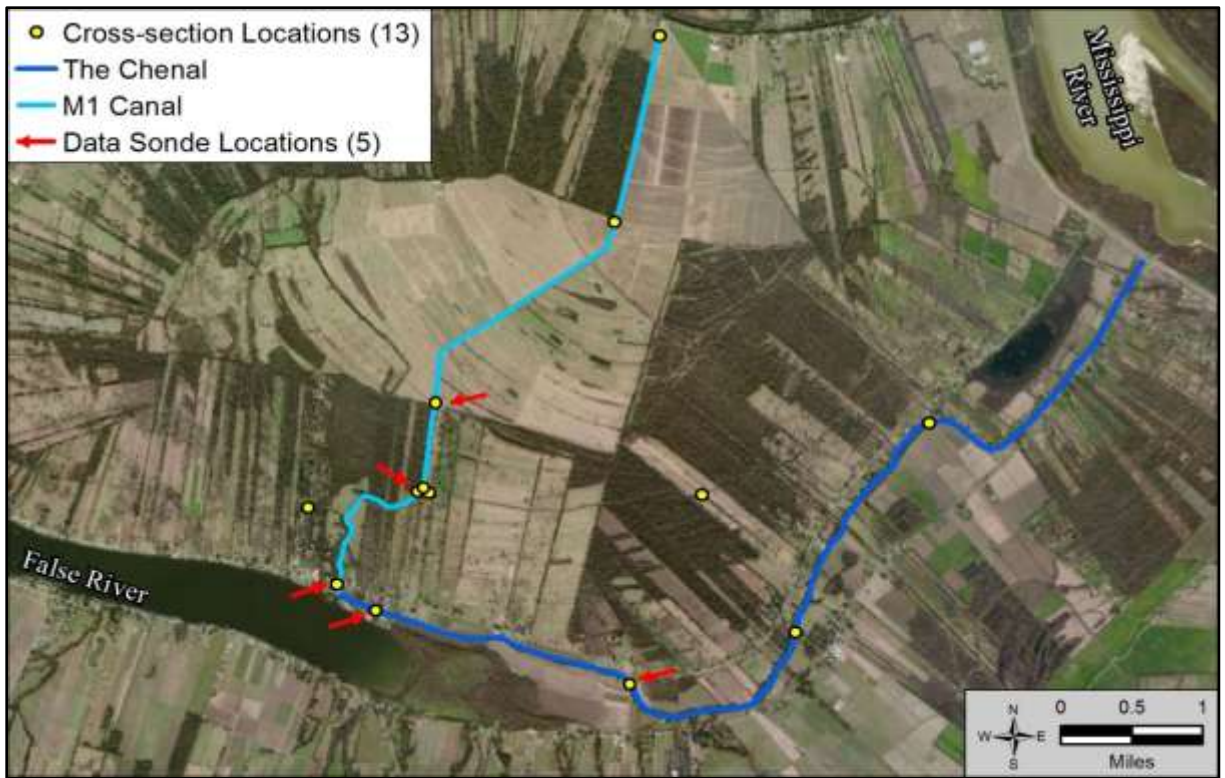

Figure 17: Location of data sondes on The Island drainage network

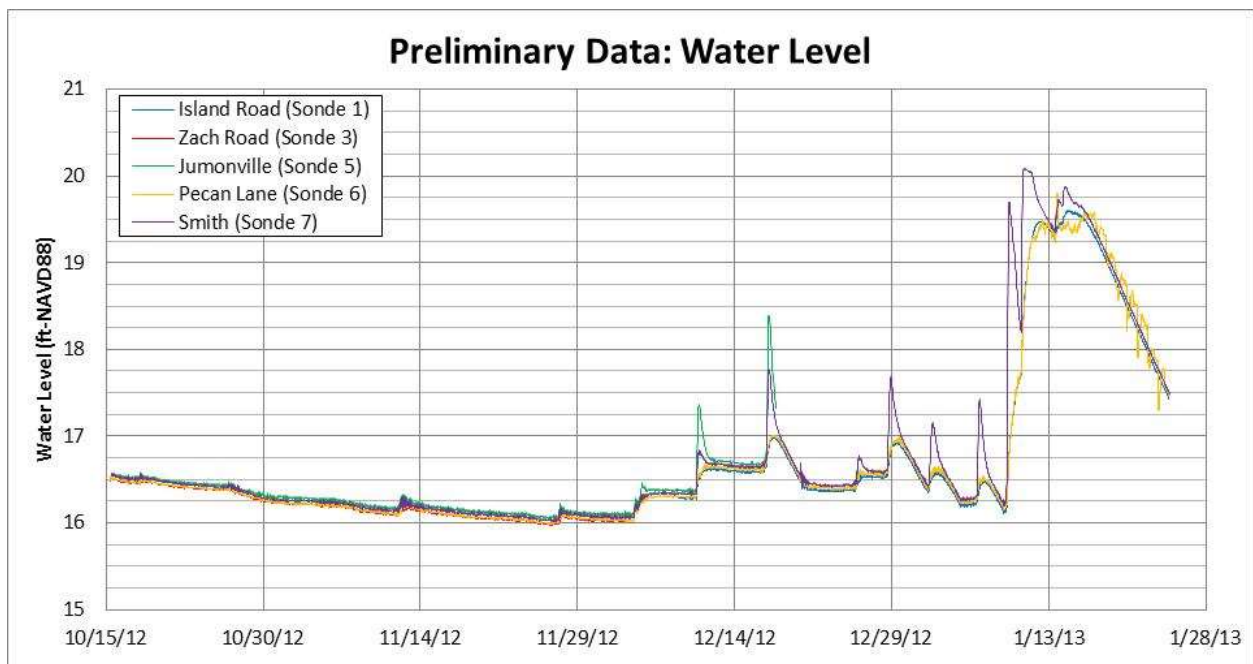

Figure 18: M-1 Canal study hydrograph

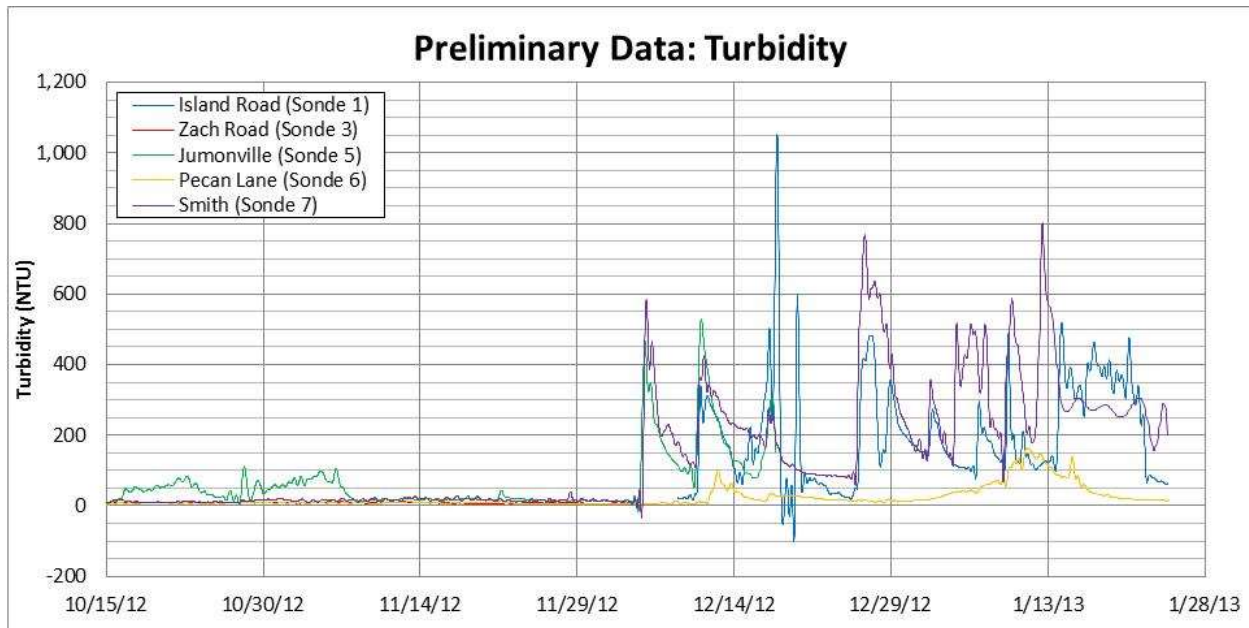

Figure 19: M-1 Canal study turbidity data

samples and precipitation data. A follow-up study of the M-2 Canal was completed by Fenstermaker & Associates LLC in 2015, integrating the whole watershed into one computer model. The new model and data collection focus on nutrients influx into the lake as well as sediment. A copy of the draft report is included in Appendix A.

### 2.2.5 Pesticides

Pesticides have been sporadically detected in False River in very low concentrations. The Louisiana Department of Agriculture and Forestry (LDAF) tested lake water for traces of atrazine in May 1997. Results showed that atrazine levels in the lake were less than 1 ppb. This low level of herbicides from agricultural runoff would not have contributed to the disappearance of lake vegetation. LDAF attributes such vegetation loss at levels between 30 – 40 ppb.

### 2.2.6 Turbidity

Limited information is available regarding the flux of particulates into False River. Turbidity data, a common surrogate analysis, is available for the lake in the late 1970s, 1990s and sporadically since (Figure 20). Data are not available for the period during which the M-1 Canal was installed and The Island reached peak crop production. The data show that in the 1990s, after the M-1 Canal sediment basin was installed, a period of elevated turbidity and Total

Suspended Solids sporadically remained. There are no standards associated with turbidity. However, the USEPA states that “higher turbidity levels are often associated with higher levels of disease-causing microorganisms such as viruses, parasites and some bacteria.”

### ***2.2.7. Sedimentation***

The existing M-1 Canal sediment basin (Figure 1) is approximately 520 feet long, by 16 feet wide, and 7 feet deep. It was built by the SCS in 1981. Limited information is available regarding the flux of sediment into False River. Total Suspended Solids data are available for the lake in the late 1970s, 1990s and sporadically since (Figure 21). Data is not available for the period during which the M-1 Canal was installed, and The Island reached peak crop production. The data show that in the 1990s, after the M-1 Canal Sediment Basin was installed, a period of elevated turbidity and Total Suspended Solids (TSS) sporadically remained. The PCPJ excavated a large amount of silt (>10,000 cubic yards – volume not recorded) from the sediment basin in 1999. In 2005, the NRCS surveyed the M-1 Canal sediment basin. In 2006 and 2010, the PCPJ excavated approximately 8,000 to 10,000 cubic yards and 1,200 to 1,500 cubic yards of silt from the sediment basin, respectively. Similar to turbidity (see previous Section), there are no standards associated with Total Suspended Solids. However, as indicated earlier, higher levels of Total Suspended Solids will most likely be associated with higher levels of disease-causing microorganisms, as those organisms are attached onto the particles.

As mentioned in Section 2.2.4, in late 2012, Fenstermaker & Associates LLC began to determine the hydrology of the Island portion of the watershed and the current level of sediment flux into the South Flats (Figure 17). A similar study of the M-2 Canal was completed by Fenstermaker & Associates LLC in 2015, integrating the whole watershed into one computer model. The model was used to evaluate hydromodifications along the drainage canals and bayous to retard flow, increase storage capacity and decrease nutrients and sediment influx into the lake. The proposed modifications were put into place with the consent of local property owners in 2017 (Figures 22 and 23). Monitoring of the lake is ongoing to determine the effectiveness of the hydromodifications. A copy of the draft report is included in Appendix A.

### ***2.2.8 Temperature***

The water temperature record for False River is somewhat noisy and sporadic. The data collected suggests that lake water temperature has been relatively stable for the last 50 years (Figure 24). LDEQ’s numerical criteria for temperature in False River is 32°C (Title 33, Part IX, Subpart 1). False River seasonally exceeds this value during the month of June, July and/or August. The highest reported temperature was on 8/2/10 at 37.9°C.



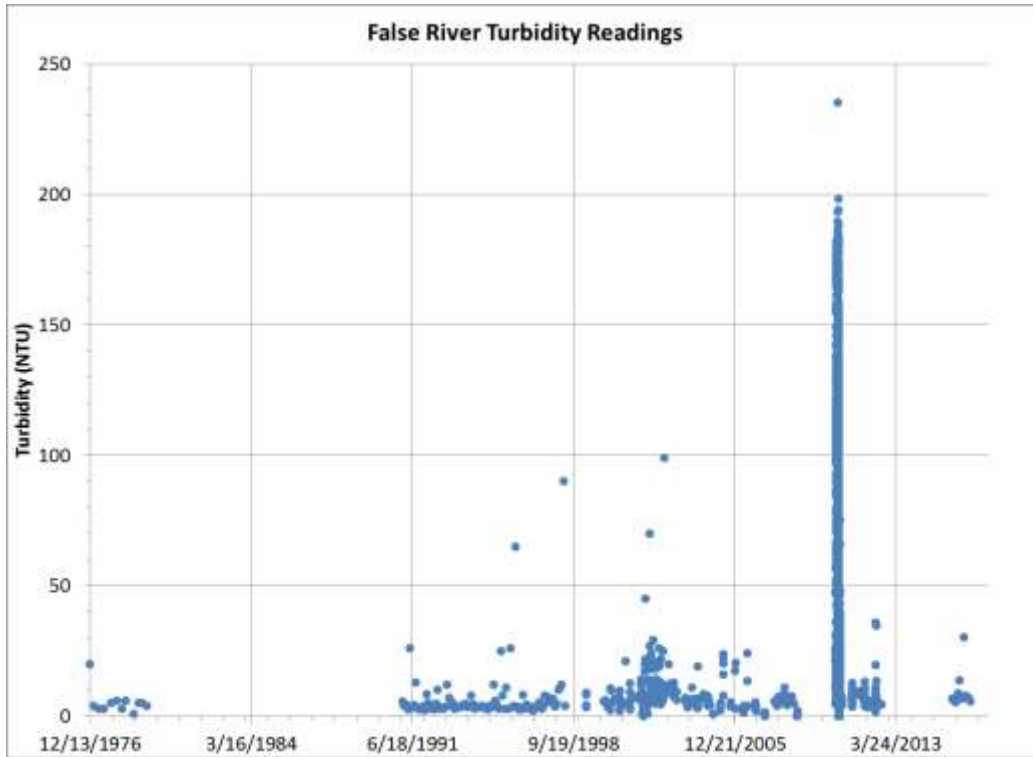

Figure 20: False River turbidity readings

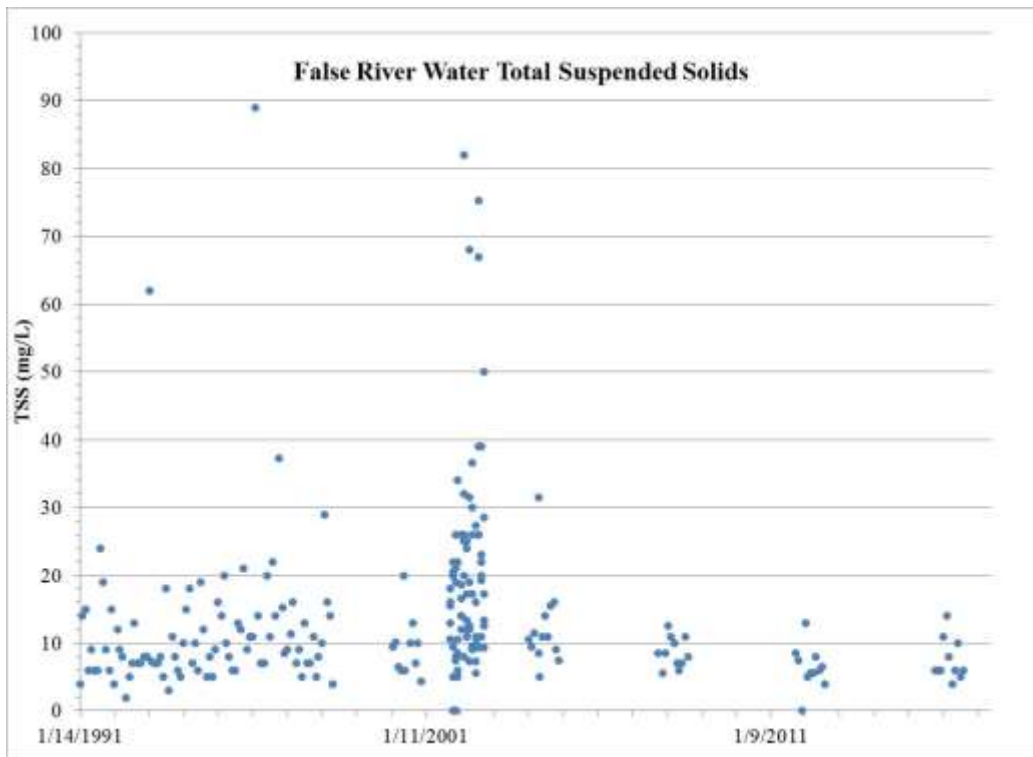

Figure 21: False River Total Suspended Solids concentrations

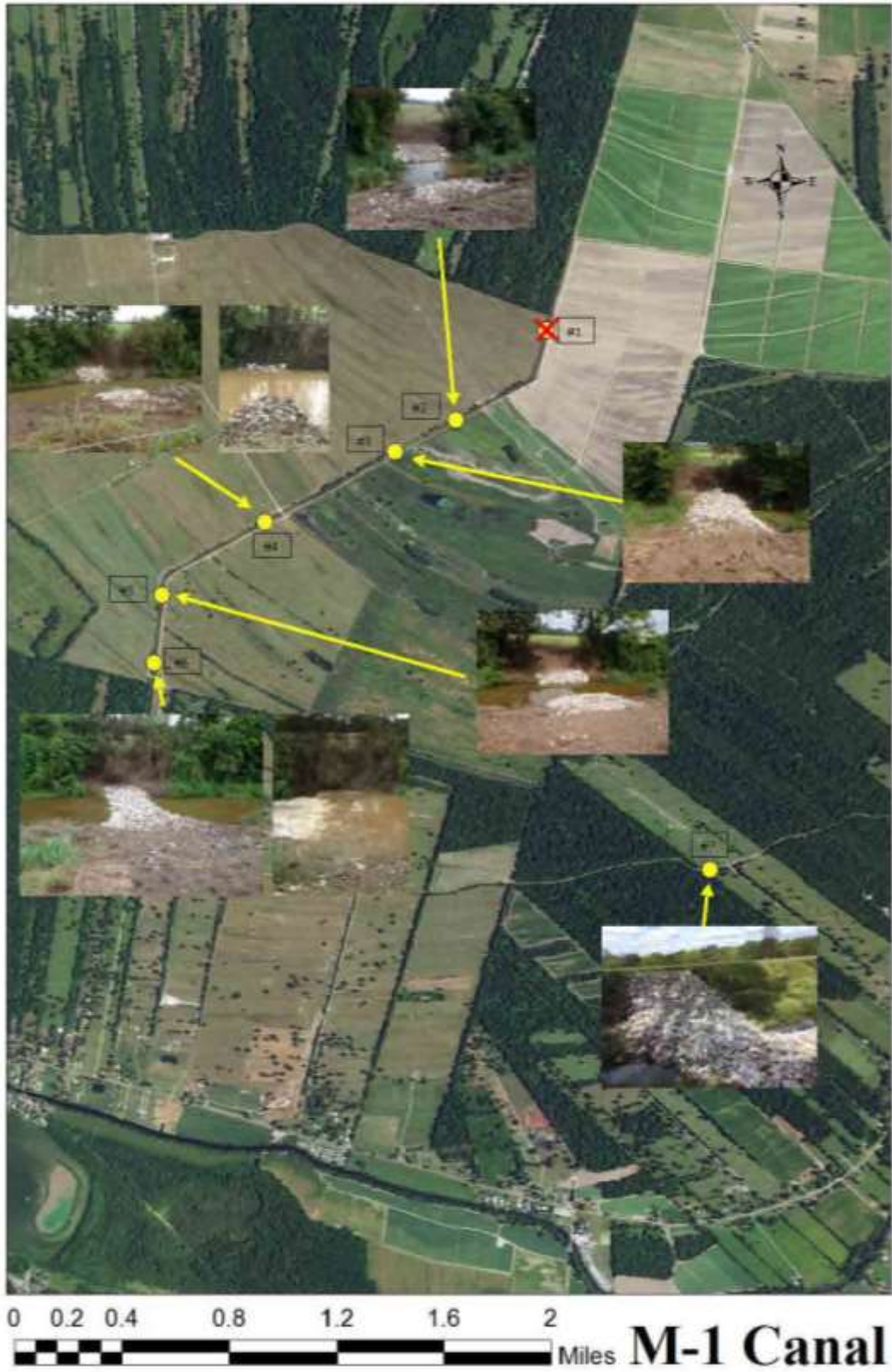

Figure 22: M-1 Canal weirs and baffles.  
 (Source: Photograph courtesy of Kevin Gravois, PEC and George O'Neal)

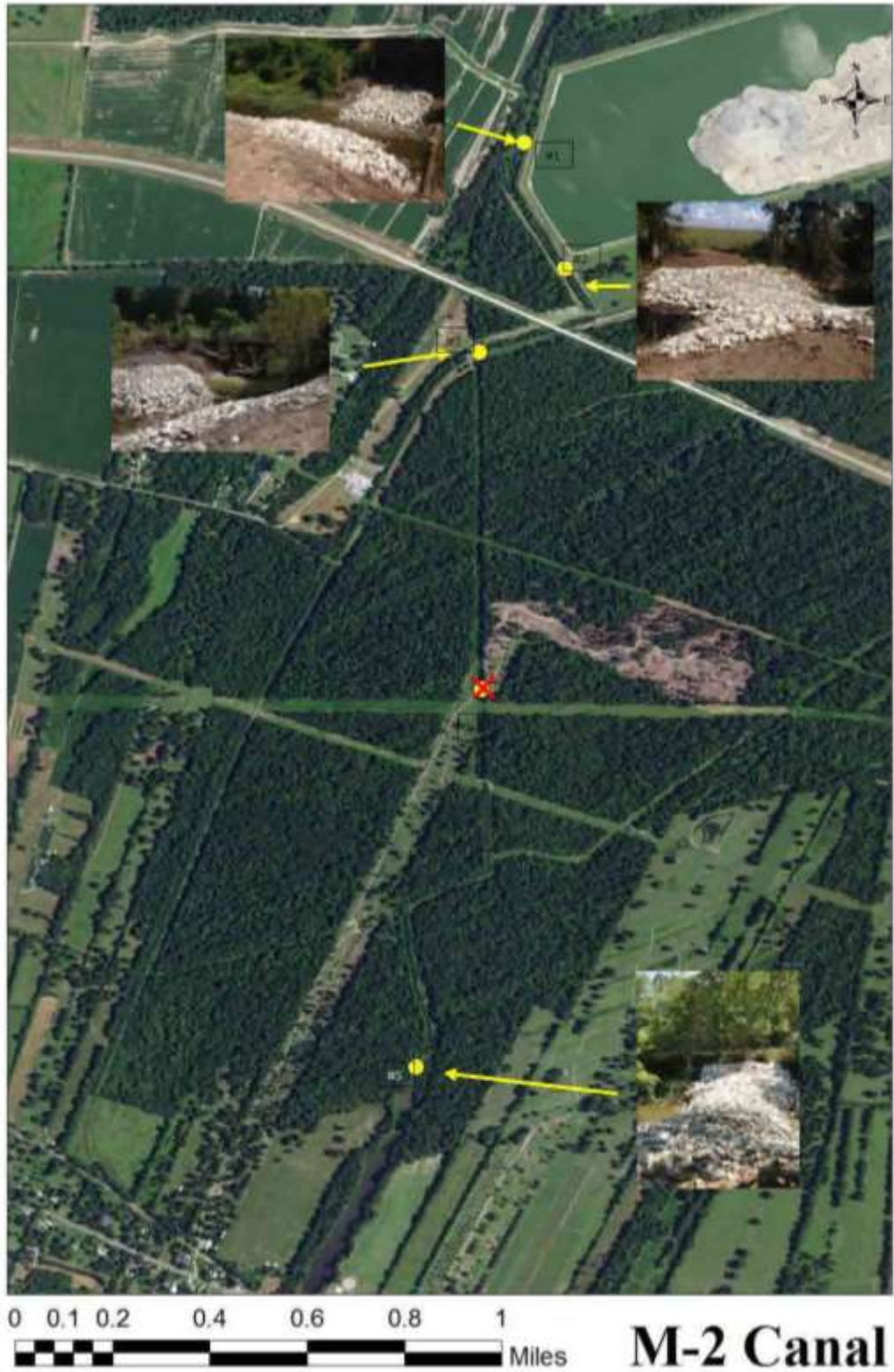

Figure 23: M-2 Canal weirs and baffles.  
(Source: Photograph courtesy of Kevin Gravois, PEC and George O’Neal)

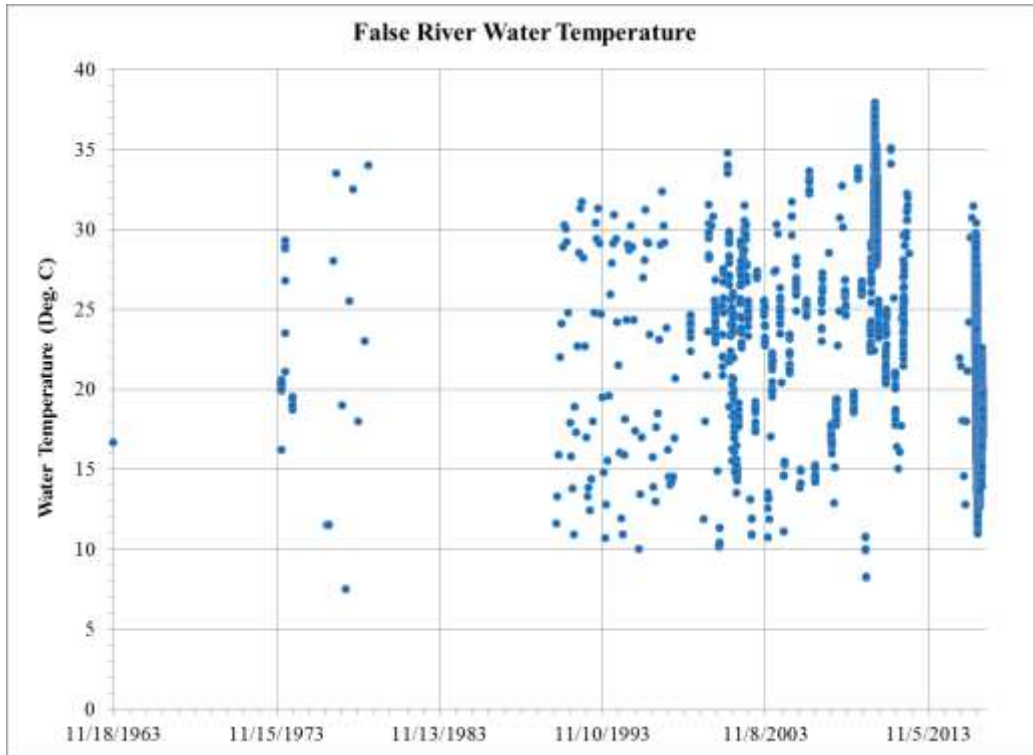

Figure 24: False River water temperature readings

## 2.3 Fisheries

### 2.3.1 Non-native Fish

Due to habitat degradation that has occurred over the years, and the increase in rough fish, particularly carp species (Figure 25), there is a need for control of these invasive fish populations. Asian carp (i.e., common carp) are present in False River. Gillnet data depicted in Figure 25 has shown an increase in carp catches, especially since 2000 [reported in catch-per-unit-effort (CPUE)]. This is probably due to the increase of soft sediments, and the commercial netting ban that was in place until 2012.

The presence of grass carp has been documented since the late 1980s. The introduction of the invasive fish has not been authorized by LDWF. It has yet to be determined if the fish are diploid or triploid. Due to the reproductive biology of grass carp, the carp may spawn, but subsequent egg development will be unsuccessful, due to the lack of current in False River. It is speculated that the presence of the herbivorous fish is contributing to the loss of aquatic vegetation. Capture records of grass carp in the lake are as follows:

May 1989	a grass carp weighing approximately 52 pounds is captured near the Lighthouse Canal.
----------	--

- February 1991 during routine gillnet sampling, a grass carp is netted in the south end of the lake. The fish escapes capture by tearing the net.
- December 2005 during routine gillnet sampling, a grass carp is netted in the north end of the lake.
- January 2010 during routine gillnet sampling, two grass carp are netted, one in the south end, and one near the Lighthouse Canal.
- January 2016 during routine gillnet sampling, one grass carp is netted in the south end of the lake.

### 2.3.2 Declining Stock

Due to the overall declining bass population, trophy lake status for False River was rescinded in 1998. This decline followed the completion of the Bayou Grosse Tete Watershed Project. The additional drainage lead to heavy sedimentation on the north and south ends of the lake. Consequently, this resulted in loss of spawning habitat, and virtual elimination of submersed aquatic vegetation. Since 2000, total spring electrofishing catch rate has fluctuated widely between 50 and 154 bass per hour (Figure 26). Work done to reduce erosion in the M-1 Canal in 2005 and clean out the sediment trap in 2006 was followed by a rise in quality size fish. These higher numbers indicate that more habitat is available for successful spawns. Contrary to other fish populations in the region, the fish populations of False River did not suffer from hypoxia-induced fish kills following Hurricanes Katrina (2005) and Gustav (2008).

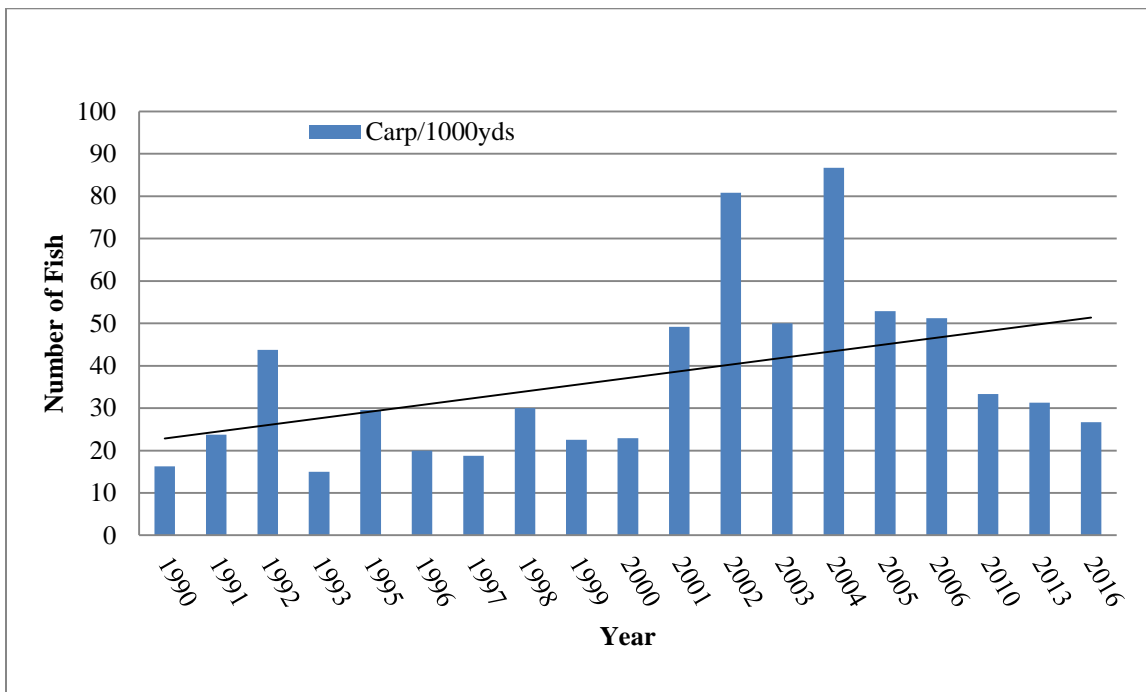

Figure 25: Common carp CPUE from gillnet samples on FR (1990 to 2016)

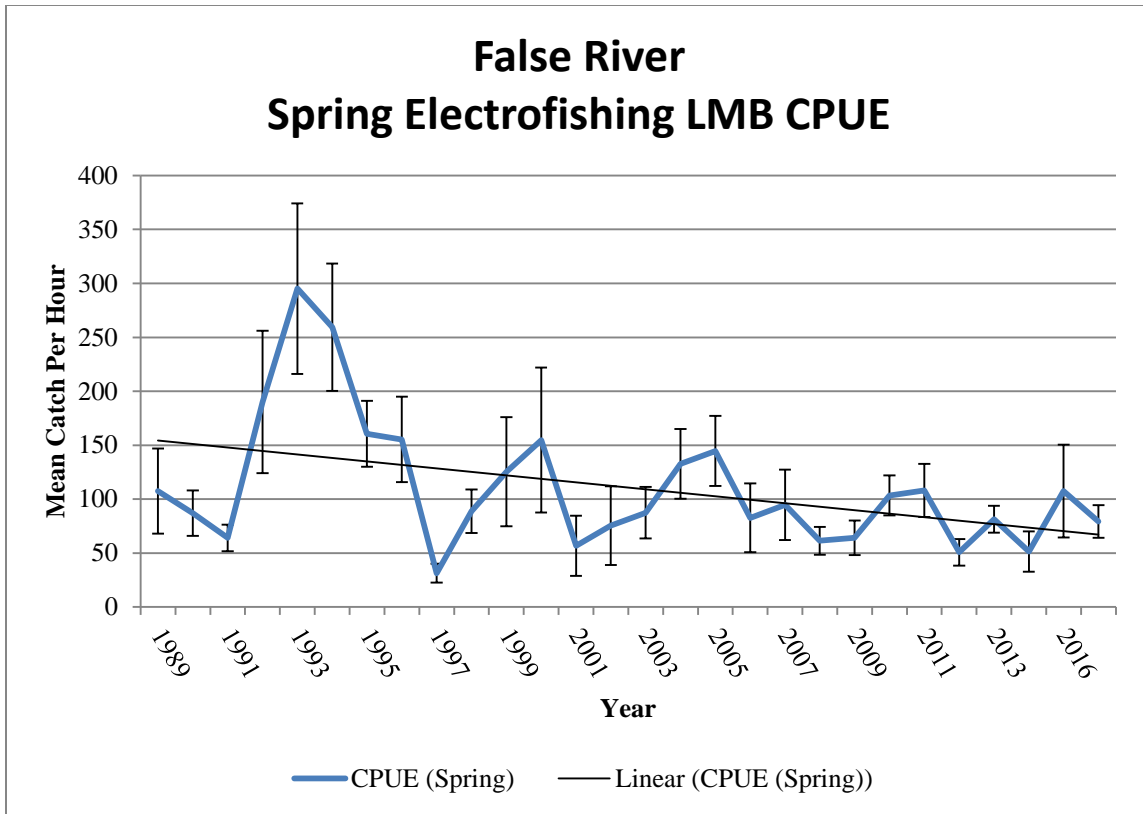

Figure 26: CPUE values for largemouth bass on FR (1989 to 2017)

## 2.4 Aquatic Habitat

### 2.4.1 Loss of Edge Habitat

False River’s watershed is comprised of 34,453 acres of mostly agricultural pastureland in the interior of the island, and mixed woodlands and pasture-land northeast of New Roads. Peak crop production was reached in the 1980s, with approximately 75% of the island under agricultural use. Currently, the total watershed area consists of 2,300 acres cropland, 1,700 acres residential/commercial, 27,353 acres of pasture and woodland, and the remaining acreage comprising the surface area of the lake. There are two main drainages in the watershed that flow into the lake: (1) Patin Dyke Slough (M-2 Canal) on the north end drains 25% of the watershed; and (2) Discharge Bayou (M-1 Canal) on the south end drains the remaining 75%. The SCS installed a sediment trap on the M-1 Canal. More recently, the NRCS fenced many of the canals in pastureland areas to reduce bank erosion. Efforts to decrease the amount of sediment discharging into False River, although difficult to quantify, are evident. Since the maintenance of the sediment trap and bank stabilization efforts, the sediment trap is apparently collecting less material, and largemouth bass stocks have increased. Also, native vegetation is starting to establish in the south flats.

#### ***2.4.2 Loss of Submerged Aquatic Vegetation***

In the 1980s, prior to completion of the Bayou Grosse Tete Watershed Project, there were dense stands of submersed aquatic vegetation on both the north and south flats of False River. There was also a fringe of submersed vegetation along the shoreline, as well as a small stand of American lotus near the south flat. By 1990, after completion of the first phase of the Project, the north flat became void of vegetation. The lake's vegetation was in steep decline for the next couple of years except for the lotus stand. Upon completion of the project, most of the lake had become void of vegetation except for some floating plants and the expanding stand of lotus. In 1993, hydrilla first appeared in the lake. Hydrilla heavily infested the shoreline on the Island side from mid-lake to the south flat and on the LA 1 side from the south flats to 1.5 miles north near the old Bonaventure landing. In 1997, aquatic vegetation was again in steep decline.

The Lewisville Aquatic Ecosystem Research Facility was funded by PCPJ to attempt to establish submersed native vegetation in 2000. It was reported in a vegetation survey by LDWF in 2003 that there was no survival of introduced vegetation, even in the enclosures that protected the plants from herbivory. Currently, there is less than 5% coverage of aquatic vegetation on the lake. There was a stand of lotus on the south flats of at least 40 acres annually. The lotus was most likely able to survive the conditions of the lake due to its ability to grow to the surface for sunlight and its substantial root system. From 2009 to 2015, lotus was not present in the lake. Following the dredging and island creation in the south end of the lake in 2014-15, lotus again returned in limited areas of the south end of the lake, primarily in the newly created channel behind the island.

Soil samples were collected from the littoral zones of the lake in January 2010. Analysis of sample nutrients and alkalinity suggest that soil conditions are suitable for plant growth. However, the instability of the soil and the continuous input of silt are not conducive to re-establishment of vegetation.

A survey of the lake in 2011 found that there was a 15 acre stand of southern naiad located in the south flats. This marks the first evidence of submerged aquatic vegetation, besides lotus, in the lake since 2001. The establishment of southern naiad is evidence that lake conditions may now be more conducive to vegetation establishment. These improvements are since the work on the M-1 Canal in 2005, and the 2010 work done on the M-2 Canal on the north end of the lake.

There is currently a lack of complex cover in False River. The deficiency is primarily due to the lack of submersed vegetation. A range of 15-30% areal coverage of complex cover is considered optimal for sportfish habitat. False River currently supports no more than 5% total aquatic plant coverage. Complex cover in False River is entirely limited to man-made structures, including piers and structures placed in the lake by anglers. In an effort to increase future angler success rate, the addition of artificial complex cover will be considered.

### **2.4.3 Boat Wake**

Elevated turbidity and sediment resuspension, particularly on the north and south ends, has been associated with boat traffic and can result into minimized spawning habitat for nesting fish. Old shell beds that once served as excellent substrate for redear sunfish spawning can become silted over. During the carp spawning season, residents along the lake complain that thousands of fish root around in the loose sediments muddying the water. These fish are also contributing to the loose sediment issues. Average depth of the flats is less than 5 feet and the loose sediments are easily stirred by boat traffic and wave action. Soil samples collected in January of 2010 showed that the flats' substrate is high in organic matter in relation to the rest of the lake's littoral zone. In September 2012 the FRWC recommended to the PCPJ a redesign of the North and South Flats no-wake zones using the recently surveyed 6 foot depth contour (Figures 27 and 28). The local Kiwanis Club set the buoys making the no-wake zones. Completion of the South Flats Island as part of the False River Ecosystem Restoration Phase I project in 2015 sequestered 159,700 cubic yards of sediment which otherwise could be remobilized by boat traffic or storm events. The 16.5 acres island (Figure 29) was built in the South Flats using dredge material from the adjoining 42 acres of shallow waters, which now are at 6 to 8 feet deep. In addition, the island created 3,500 feet of edge habitat and has become a popular fishing area on the lake. The island is posted with "No Trespassing" signs, as the ground may remain soft for some times.

The False River Ecosystem Restoration Project - Phase II which began in 2015 seeks to remove approximately 250,000 cubic yards of sediment from the North Flats and provide for another lift of sediment onto the South Flats Island to compensate for naturally occurring sediment compaction and consolidation. The North Flats sediments are planned to be dredged and piped onto a property on The Island made available by a local owner. The sediment will be mechanically dewatered and stockpiled for later use by the owner as fill material.

## **2.5 Land Use Development**

### **2.5.1 Shoreline Development**

The natural shoreline of any lake in southern Louisiana is usually a very gentle slope with vegetation at the water's edge and up the slope. This situation allows wave energy to be gradually dissipated both incoming and returning to the lake. As the developments around False River continue to increase, the value of the waterfront real estate has escalated. This has led to a situation where property owners, either in an effort to protect their structures or to increase their land area have constructed vertical bulkheads. These bulkheads are becoming more and more prevalent on the False River shoreline. During lower lake level periods and generally after a heavy rainstorm, damage to some types of shoreline treatment could be observed. In 2016, the FRWC released an information flyer to assist property owners in selecting a shoreline protection treatment (Appendix B).



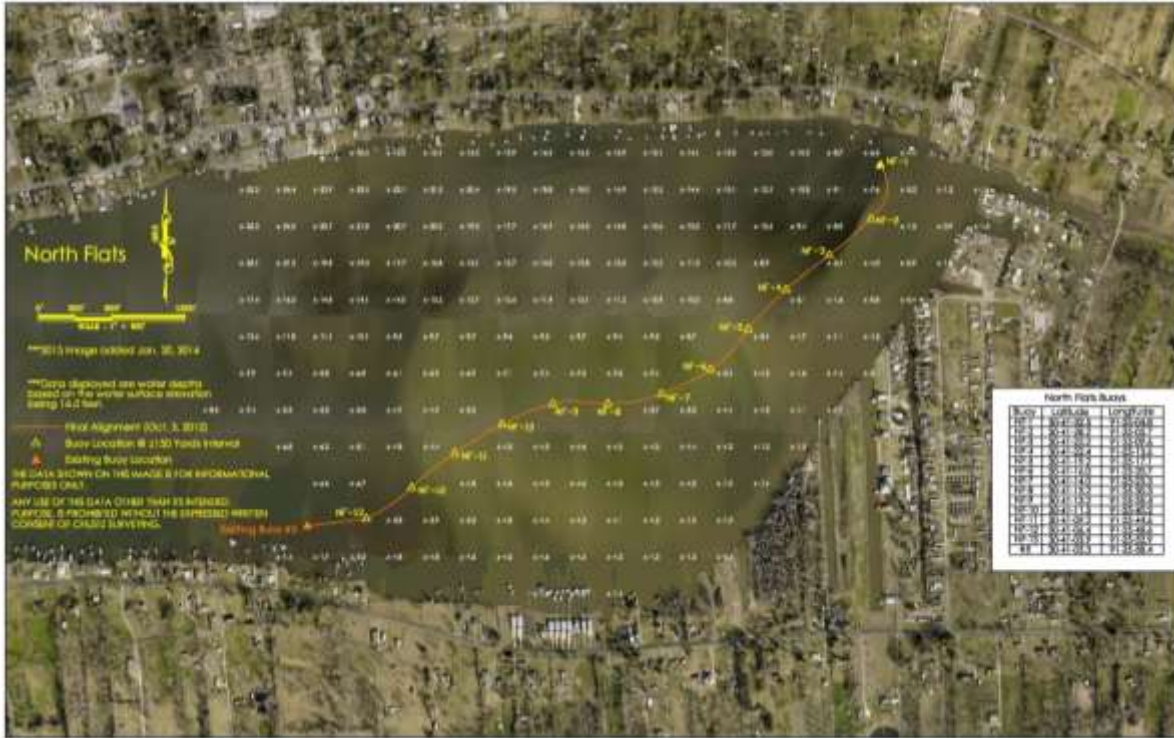



Figure 29: South Flats Island nearing completion.  
(Source: Photograph taken 8/13/15 courtesy of Randy Boyd, RLB Contracting Inc.)

### **2.5.2 Bulkheads**

As the length of vertical bulkhead shoreline has increased, it has created unintended erosional and turbidity problems. In short, vertical bulkheads cause increased erosion of the lake bottom seaward of the bulkhead. Waves, especially breaking waves, impacting a vertical surface have a large portion of their energy directed downward to the mudline. This downward moving water erodes the bottom sediments as it retreats from the bulkhead. The eroded sediments increase the turbidity in False River while increasing the water depths seaward of the bulkheads. As indicated earlier, the drawdown of 2014 and 2016 exposed deficiencies in the selection of material, design and construction of shoreline protection treatment. Specifically, it was observed that some bulkheads were poorly designed, installed and protected from erosion. To address these issues, the FRWC in collaboration with local citizens and, in 2017, the PCPJ proposed an ordinance that would assist property owners select and build more appropriate and resilient shoreline treatment for the lake. The proposed ordinance and later revisions were approved the PCPJ. A copy of the latest approved ordinance is included in Appendix C.

### **2.5.3 Piers, Boathouses and Boatlifts**

There are numerous piers, boathouses and boatlifts along the False River shoreline, including abandoned pier and other structures in disrepair. These structures and the boat traffic associated with them create shade and disturbance which can limit aquatic plant growth and reduce fish habitat. In addition, construction and maintenance activities can cause the loss of shoreline vegetation and an increase in turbidity.

### **2.5.4 Sewerage Systems**

There are numerous camps and residences along False River serviced by individual sewerage system. In the late 1990s and early 2000s, the PCPJ investigated the source of elevated fecal coliform counts measured in the lake's water (Figure 11). The PCPJ and other stakeholders remedied the sources identified by repairing and extending sewers. In addition, the LDH is requiring the update of individual waste treatment systems when a property transfer occurs. Recently, the PCPJ has made an application to LDH in order to finance the expansion of sewer service around the lake.

### **2.5.5 Drainage Systems**

LDNR obtained and reviewed the 2012 Pointe Coupee Parish Drainage Master Plan. The 2012 Plan is consistent with the mandate of the FRWC. LDNR is evaluating impacts to the False River Watershed and will discuss any suggestions with Parish officials and the FRWC as the various projects are implemented.

## 3 Management Strategies

### 3.1 Flooding

#### 3.1.1 Lake Level Management

##### 3.1.1.1 Natural Cycle

False River is an inactive oxbow of the Mississippi River. Current lake levels are stabilized at 16' MSL with limited seasonal fluctuations (Figure 3). Historically the lake was connected to the main river channel and water levels are reported to have fluctuated upwards of 30 feet annually. To improve the health of the lake, water levels are currently managed to the extent practical to mimic more natural seasonal fluctuations. Fluctuating water levels are dependent on the capacity of the control structure at the Lighthouse Canal. Typical annual Mississippi River fluctuations are low water levels in the late summer and winter months (July–January), and high water levels in the spring and early summer months (February– June). The last naturally occurring low stage was recorded in 2000 (Figure 30). During this drought period the lake level reached 13.7 ft NGVD (11.9 ft NAVD). In 2014, at the recommendation of the FWRC and to facilitate the construction of the South Flats Island, the PCPJ lowered the lake level approximately 2.5 feet (Figure 10 - approximately the levels observed during the 2000 drought). The drop in lake level exposed the sediments in the South Flats (Figure 31) and fostered the growth of aquatic vegetation.

##### 3.1.1.2 Tropical Storm/Flooding Event

In order to increase the volume of water that False River can store during large rain events such as tropical storms, the short-term lake level management has been addressed by the PCPJ by preemptively opening the gates of the Lighthouse Canal structure. In addition, the spillway on Bayou Sere has been recently renovated to allow for additional discharge from the lake at stages above 16.5 feet, although an obstruction remains that needs to be addressed. This management procedure is consistent with recommendations made by a local civic association, although the rate at which the lake is lowered may need to be further addressed.

As indicated earlier (Sections 2.2.4 and 2.2.7), an engineering firm collected hydrologic data along Discharge Bayou, including the M-1 and M-2 Canals and their tributaries, False Bayou and the Chenal (Figure 1) to assess the hydrologic response of the watershed to storm events and model the current hydrologic conditions. Figure 32 compares the hydrograph of the August 16 16 (>20-inch) storm and the October 2017 (~15-inch) storm. Although the storms are not identical nor do they have identical antecedent conditions, the 2017 (post-hydrmodification) storm show similar in-flow (rise), but a different outflow with a lower angle, longer fall and potentially shows a longer lag time on the flood peak which may indicate the hydrmodifications implemented may be having the desired effect.



Figure 30: Exposed sediments during the 2000 drought.  
(Source: Photograph taken 10/29/00 courtesy of Jimmy Bello, PCPJ)



Figure 31: South Flats sediments exposed during the 2014 drawdown.  
(Source: Photograph taken 1/20/14 courtesy of Gerald Babin, PEC Inc.)

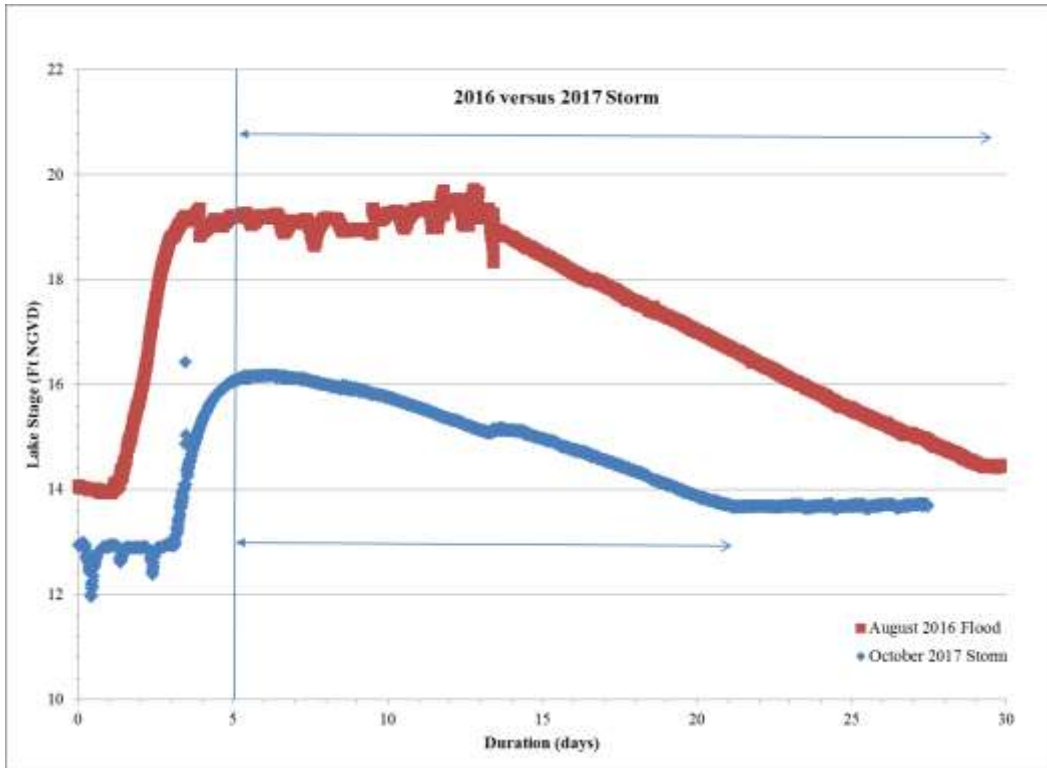

Figure 32: Hydrograph comparison of the August 2016 and October 2017 storm events.



Figure 33: North Flats sediments exposed during the 2016 drawdown.  
 (Source: Photograph taken 1/5/17 courtesy of Brian Heimann, LDWF)

### *3.1.1.3 Other Lake Level Management Issues*

Lake level management can be a useful tool to improve water quality. Exposure of shallow water areas have the beneficial effect of hardening the lake substrate resulting in improvement in lake water quality from decreased turbidity, and improvement in fish habitat. Similarly, periods of low water level can be used by camp and home owners to perform shoreline maintenance on piers and bulkheads. In 2014, at the recommendation of the FWRC and to facilitate the construction of the South Flats Island, the PCPJ lowered the lake level approximately 2.5 feet (Figure 10 - approximately the levels observed during the 2000 drought). The drop in lake level exposed the sediments in the South Flats (Figure 31) and fostered the growth of aquatic vegetation. In 2015, the lake was again lowered by the PCPJ on order to perform maintenance on the control structure. At the request of LDWF, and with the recommendation by the FRWC, the PCPJ began after the flood of 2016 the first major drawdown of the lake to improve the lake fisheries. The drawdown lowered the lake 6.6 feet and exposed sediments in both the North (Figure 33) and South Flats. Based on the observations made during the successful drawdown of 2016, the LDWF recommended to the FRWC and PCPJ that the lake be scheduled for routine drawdown. LDWF proposed schedule was another drawdown for 2017 and then drawdowns every three years (2020, 2023 and 2026). The recommendation was approved by the FRWC and the PCPJ. The 2017 scheduled drawdown began after Labor Day but was aborted by LDWF after a major rain event (15-inch) in late October 2017 which refilled the lake within a two-day period. LDWF indicated that they would potential consider 2018 to make-up the drawdown. This decision will take in consideration the scheduling of the North Flats dredging associated with the False River Aquatic Resources Ecosystem Restoration Project – Phase II. The dredging can only be performed with the lake levels being at or near pool stage.

## **3.2 Water quality**

### *3.2.1 Nutrient Run-off Management*

As indicated in Section 2.2 of this report, there has been quite a bit of interest in False River over the years, resulting in other agencies and organizations collecting water quality data in the lake. PCPJ, LDWF, USGS, USEPA, Gulf Engineers & Consultants, Inc. (GEC) and LDH have each collected water quality data at various locations and times over the years. GEC collected water quality and sediment data during July, August and September 2010 at several locations.

LDEQ has collected water quality data on False River (subsegment 120108) from January 1991 through September 2012, at an ambient site south of New Roads. These data were collected annually between January 1991 and May 1998, and then on a cyclic schedule from 2000 through 2011/2012, including 2000, 2004, 2007/2008 and 2011/2012. Nitrogen as nitrite-nitrate ( $\text{NO}_2/\text{NO}_3$ ) exhibits seasonal patterns with higher values (0.2-0.6 mg/L) from November through February and lower values below 0.2 mg/L from March through October. Average annual  $\text{NO}_2/\text{NO}_3$  values have increased during the 2007/2008 and 2011/2012 ambient sampling cycles.

Total Kjeldahl Nitrogen remains relatively consistent throughout the year with values of 1.0-1.5 mg/L, and with one extreme value of 57.6 mg/L on August 1, 2000. Similarly total phosphorus (TP) concentrations remained relatively consistent, with values below 0.2 mg/L, with a few exceptions and one extreme value of 24.44 mg/L on August 1, 2000. Average annual TP values have also remained relatively constant except during 2000, due to the high value in August.

LDEQ's Nonpoint Source Program (NPS) has developed a Management Plan that includes types of best management practices (BMPs) that could be utilized to reduce NO<sub>2</sub>/NO<sub>3</sub>, TP and turbidity from agricultural activities such as crops and pastures. Appendix D includes a set of BMPs designed by USDA to reduce sediment, nutrients, pesticides, organic material and bacterial concerns in surface waters from croplands and a set of BMPs to reduce these pollutants from pasturelands. In addition, the implemented hydromodification within the watershed will further be evaluated through monitoring of the lake water to determine their effect on nitrogen loading into False River. If necessary, additional modifications will be implemented to further foster nutrients assimilation in vegetation buffer/filter zone, grassed bench, as well as other vegetative edge/riparian habitats, and retarding surface water runoff and stream flow by drainage network modification.

### ***3.2.2 Sediment Run-off Management***

LDEQ's data reflected concentrations of Total Suspended Solids (TSS) which fluctuate throughout the year, with values typically ranging from 5-20 mg/L, and a few extreme values of more than 60 and 90 mg/L during January and February, respectively. Average annual concentrations of TSS have fluctuated from 1991-2011/2012, but have declined since 2004. Turbidity values in False River have typically remained below 10 nephelometric turbidity units (NTU), with only five (5) exceedances above the state's NTU guideline of 25 for fresh water lakes. Similar to TSS, average annual NTU values have fluctuated from 1991-2011/2012 but have declined since 2004.

GEC also collected turbidity data from July 12, 2010 through September 20, 2010, with high values over 100 NTU at site FRS-2 on July 20, 21, and above 40-50 on July 22 and from 50-150 on July 23-26, but returned to a normal range below 20 NTU by July 27th, followed by a few high values on August 5th and 8th, with one extreme value of 235.2 NTU on March 8th. A few values above 40 NTU on August 9th and 10th were observed from August 11th - 30th, two sites, FRS-2 and FRN-1, had values above 100 NTU, but dropped by August 31st and returned to normal by September 1, 2010. LDEQ's ambient water quality data collected south of New Roads from October 2011 through August 2012, indicated NTU values below 10.

#### ***3.2.2.1 Sediment Control Ordinance***

A sediment control ordinance is currently being drafted, based on a model ordinance obtained from the USEPA, to address soil disturbing activities within the watershed and provide for



measures to decrease the sediment flux to the lake. The draft ordinance developed will be submitted to the Pointe Coupee Police Jurors for their consideration.

#### *3.2.2.2 Servitude Ordinance*

The PCPJ has a 100-foot easement on both sides of the channels they maintain. Currently agricultural activities occur within this easement. An ordinance is being drafted to change land use in part of this easement and allow for a buffer zone between agricultural activities and the drainage channel. NRCS or other conservation funds will be considered to offset any impact to the landowner.

#### *3.2.2.3 Operation and Maintenance Plan*

The PCPJ is planning to implement the routine cleaning of the drainage Canals, sediment basin and to continue making improvements to reduce erosion and sediment runoff into False River. They plan to continue with the routine maintenance and inspection of False River's drainage network. A draft Operation and Maintenance Plan developed by LDNR has been submitted to the Pointe Coupee Police Jurors for their consideration.

#### *3.2.2.4 Land-Use Management*

Two companies proposed establishing mitigation banks within The Island portion of the watershed. The Ponderosa Ranch of Pointe Coupee is currently in its second phase expansion encompassing 707.8 acres. The Grand Swamp has withdrawn its application to become a Permittee-Responsible Mitigation (PRM) encompassing 215.1 acres. A total of 923.9 acres of pasture and cropland within The Island has now been restored and is no longer contributing excessive amount of sediment to the lake.

#### *3.2.2.5 Channel Hydromodification*

To address the changes that were made by the SCS to the watershed, Fenstermaker & Associates LLC is continuing to collect data and report on the drainage network to determine the effectiveness of the hydromodification on the watershed, including the current level of sediment flux into the Flats.

### ***3.2.3 Private/Public Sanitary Effluent Management***

Currently, LDH is requiring the update of individual waste treatment systems when a property transfer occurs, and many of the outdated systems have been replaced by newer units. In addition, the PCPJ has a grant application in with LDEQ for \$100,000 for evaluation of The Island sanitary sewer system. The implementation is projected at \$5-6 million and is not currently funded. LDNR is working with LDH to make information on its website available regarding when new sewer systems are required and BMPs for existing individual waste water treatment systems. Information obtained to date has been placed on the LDNR website (<http://dnr.louisiana.gov/index.cfm?md=pagebuilder&tmp=home&pid=924>).

### **3.2.4 Storm Flow Management**

#### *3.2.4.1 Sediment Control Ordinance*

A sediment control ordinance is currently being drafted, based on a model ordinance obtained from the USEPA, to address soil disturbing activities within the watershed and provide for measures to decrease the sediment flux to the lake. The draft ordinance developed will be submitted to the Pointe Coupee Police Jurors for their consideration. In addition, the FRWC proposed the development of BMPs for False River Watershed in collaboration with LDEQ related to home construction and other items that may cause runoff issues and provide to PCPJ for consideration to use as part of building permit process or to otherwise make available.

#### *3.2.4.2 Servitude ordinance*

The PCPJ has a 100-foot easement on both sides of the channel they maintain. Currently agricultural activities occur within this easement. An ordinance is being drafted to change land use in part of this easement and allow for a buffer zone between agricultural activities and the drainage channel. NRCS or other conservation funds should be considered to offset any impact to the landowner.

#### *3.2.4.3 Operation and Maintenance Plan*

The PCPJ is planning to implement the routine cleaning of the drainage Canals and sediment basin and to continue making improvements to reduce erosion and sediment runoff into False River. They plan to continue with the routine maintenance and inspection of False River's drainage network. A draft Operation and Maintenance Plan developed by the FRWC has been submitted to the Pointe Coupee Police Jurors for their consideration.

#### *3.2.4.4 Channel Hydromodification*

To address the changes that were made by the SCS to the watershed, the hydromodifications proposed by the Fenstermaker & Associates LLC study (Appendix A) were implemented. Monitoring of the Lake, including sediment and nutrients fluxes is ongoing.

### **3.2.5 Shoreline Modification Management**

Shoreline modifications are prevalent along most of False River, in the form of shoreline hardening and bulkheads. The vertical aspect of bulkheads causes erosion, turbidity and wave within the lake. Mitigation of wave energy from vertical bulkheads can be accomplished by multiple methods including the following treatments:

- (1) placement of a debris fence (commonly referred to as Christmas tree fences), these are easy and relatively inexpensive to construct and can be very effective in removing wave energy from the shoreline (Figure 34). These structures could be built seaward of the bulkhead, approximately 10-15 yards in front to remove the wave energy from

the bulkhead. They also have the potential to create a fish habitat that currently does not exist. These fences have been used for many years by coastal parishes in their coastal restoration efforts. The debris fences allow water to filter through while eliminating the wave energy.

- (2) placement of rip-rap in front of the vertical bulkhead to create a porous sloped surface. This would allow the wave to gently run up the slope while dissipating energy on the irregular surface. Prior to doing this, we suggest the property owner have their bulkhead evaluated by a Professional Engineer to insure that the material's placement will not have an adverse impact on their bulkhead or any adjacent structure.

Any shoreline treatment that mimics the lake's natural shoreline and provide edge habitat would be a huge advantage over vertical bulkheads. There are several methods to "harden" a shoreline while having it appear to be natural. This method uses gentle slopes and vegetation to dissipate wave energy.



Figure 34: Examples of shoreline mitigation treatments

The FRWC proposes to address shoreline modifications issues through three actions as follows:

- (1) EDUCATE. The vast majority of False River property owners are not aware of the harmful effects that vertical bulkheads have on their lake's environment. FRWC proposes an educational outreach effort to make property owners aware of the current conditions. A handout illustrating the benefit of more natural shoreline has been made available (Appendix B). Many property owners, once aware of the issue will take steps to mitigate the situation on their property.
- (2) ENTICE. While many owners will undertake effort and expense to correct an issue once aware of the problem, others may choose not to mitigate or not be financially able to make the changes. FRWC suggests that an enticement or incentive program be created to

assist property owners that wish to perform mitigation efforts, such as making equipment, labor or materials available at no or minimal charge.

- (3) ENFORCE. An new ordinance (Appendix C) is being enforced by the Pointe Coupee Police Jurors that assist in the proper design, construction and upgrade of new and existing vertical bulkheads and other shoreline treatments.

FRWC and PCPJ is addressing the matter of ownership of water bottoms with the State Land Office. It is likely that debris fences and rip-rap placed in front of the bulkheads may be constructed on State-owned water bottoms. Once those issues are resolved, the shoreline policy should be implemented.

### ***3.2.6 Watershed Conservation Measures***

Over the last several years, there has been an intensive effort to implement watershed conservation measures within the False River Watershed. These measures are part of an ongoing effort between LDAF through the Soil and Water Conservation Districts (SWCD) and NRCS. Conservation practices in the False River watershed implemented through USDA/SWCD cost-share, incentive, and easement programs from 2008 to present, include the following:

- (1) Environmental Quality Incentives Program (EQIP) that allows producers to implement conservation practices to address natural resource concerns on eligible land. Primary practices include cross fencing, waterlines for livestock, watering systems/troughs, heavy use area protection, pasture planting, water wells for livestock and well decommissioning.
- (2) Wetland Reserve Program (WRP) allows producers to implement practices intended to restore, protect, and enhance wetlands on eligible lands. Primary practices include bottomland hardwood reestablishment and hydrologic restoration.
- (3) Grasslands Reserve Program (GRP) works with producers to restore and protect rangeland, pastureland, and other grasslands while maintaining the land's suitability for grazing on eligible land. Primary practices include grazing land/grassland management, rotational grazing, cross fencing and critical area planting.

A considerable number of outreach efforts have been conducted in the False River Watershed. These include the following:

- (1) Upper Delta Soil & Water Conservation District. Locally-led natural resource needs identification meetings in New Roads, LA. These locally-led meetings are not specific to the False River watershed, but are public meetings designed to assess and prioritize natural resource concerns across Point Coupee Parish. At these meetings, the False River watershed is occasionally listed. Previous meetings occurred during the spring of 1997, 2002, 2008, 2009, 2010, 2011, 2012 and 2013.

- (2) False River Watershed Informational Public Meetings and Feasibility Report and Environmental Assessment. Included public involvement, review, and consultation with the USACE (fall 2002 and 2011), the False River Civic Association (1999), the Farming and Rural Conservation Agency, LDNR, LDWF, PCPJ (2011 and 2012).

In addition, the LSU AgCenter has developed agricultural BMP manuals for each Louisiana commodity. Commodity manuals applicable to commodities in the False River watershed are included in Appendix E.

### 3.2.7 *Habitat Restoration*

#### 3.2.7.1 *Artificial Reefs*

Due to shoreline modifications and the absence of aquatic vegetation, False River has minimal complex cover available for fishes. FRWC recommends developing and implementing an artificial reef project. The addition of artificial structures will provide needed cover for sportfish and increase angler success. FRWC also recommends working with local sponsors to secure funds, materials and labor.

#### 3.2.7.2 *Spawning Beds*

Siltation has covered many of the natural hard bottoms (i.e. shell beds) in False River. During the drawdown in 2016/2017, LDWF confirmed the presence of a 40-plus acre shell bed hard bottom in the vicinity of the North Flats. Hard bottoms serve as spawning habitat for nesting sportfish. The objective is to enhance spawning habitat in the lake by the addition of gravel beds. Gravel beds have been created in locations that were either historic sites of natural shell beds or deemed suitable by LDWF Inland Fisheries biologists (Figure 35). The installation of multiple gravel beds will provide spawning habitat for nesting sportfish. FRWC will identify incentives to encourage camp and home owners to assist in the placement of beds.

<b>GRAVEL BED SITE</b>	<b>COORDINATES</b>	
Island side north	30.67616	-91.45856
Across from hospital	30.682943	-91.444377
Island Queen	30.643352	-91.481402
Across from public landing	30.683388	-91.432734
Bergeron Pecans	30.67420	-91.47068
Hospital	30.68256	-91.46001
Public landing	30.692011	-91.436095
LA Xpress	30.61571	-91.43414
Sandbar	30.61344	-91.44904
South Island	30.60724	-91.43124

Figure 35: Locations of gravel spawning beds placed in False River

### *3.2.7.3 Vegetation Planting*

Siltation issues and habitat degradation from undesirable fish species (e.g. the unauthorized introduction of grass carp) has led to the almost complete absence of aquatic vegetation in the lake. Native aquatic plant species suitable for establishment in False River, along with suitable lake conditions and locations for planting, shall be identified. Once all criteria are identified and satisfied, plantings shall begin as funds are available.

### *3.2.7.4 Creation of Island/Terrace Habitat*

The USACE, in their proposed restoration strategy for the lake, has indicated they would rely on dredging the lake sediments to create one or more island/terrace and promote the establishment of aquatic “edge” habitat as a potential restoration measure. Aquatic habitat establishment would provide beneficial complex fish environments which have been lost due to siltation and shoreline modifications. The construction of the island/terrace would coincide with a limited drawdown of the lake to promote hardening of the lake substrate and reduce turbidity.

FRWC recommended in 2012 using Capital Outlay funds for the creation of islands/terraces. The islands created in the South Flats improved wildlife habitat, wave attenuation, water temperature cooling, turbidity reduction and overall water quality. The lack of local support for an island within the North Flats changed the focus of the project toward the removal and landfilling of the sediments. The permitting and dredging of the North Flats are planned to begin in 2018 and be completed in 2019 based upon an estimate of funding that may become available this year.

## **3.2.8 Fisheries Management**

### *3.2.8.1 Seasonal commercial harvest of rough fishes*

FRWC recommends continuing to implement a recurring commercial net season to allow for the take of rough fishes, and to continue to monitor rough fish populations through seasonal gill netting.

### *3.2.8.2 Stocking*

FRWC recommends continuing to evaluate the fisheries and make recommendations to LWDF for fish stockings. A list of fish stocked in False River since 2012 can be found in Figure 36.

### *3.2.8.3 Standardized Sampling*

FRWC recommends continuing standardized sampling of fish populations to evaluate the conditions of the stock and evaluate nesting species success. A comprehensive three-year age, growth, and mortality study of largemouth bass was completed in 2012. Results of data analysis have allowed for informed consideration of harvest regulations and available through LDWF.

SPECIES	NUMBER & SIZE
Florida largemouth bass	26,791 fingerlings & 301 adults
Redear sunfish	306,147 fingerlings
Bluegill	314,928 fingerlings
Hybrid striped bass	79,018 fingerlings
Alligator gar	43 sub-adults
Striped bass	10,000 fingerlings

Figure 36: Species, number and size of fish stocked by LDWF in False River since 2012.

#### *3.2.8.4 Siltation*

FRWC recommends determining the current conditions of lake siltation and turbidity. Work with PCPJ, LDNR, NRCS, LDEQ and USACE to secure funds for projects to address these problems. LDNR has an ongoing project researching the contribution of sediment to the lake from the watershed and evaluating solutions to address the contributions, as necessary.

#### *3.2.8.5 Monitor Grass Carp*

FRWC recommends continuing to monitor grass carp populations in the lake, to work with LDWF and USGS to determine ploidy of the population, and to investigate other potential herbivores and exotic species in the lake.

#### *3.2.8.6 Limnological Survey*

Purpose is to monitor lake health and productivity. FRWC recommends that this work be performed in conjunction with Louisiana State University. Proposal for project has been submitted. Project will begin once funding is secured.

### ***3.2.9 Coordination of Federal, State, and Local Efforts to Improve and Protect Water Quality; Surface Water Resource Management and Protection Policies***

The PCPJ has modified the extent of the no wake zones in the North and South Flats. Surveying has been completed and information provided to the PCPJ and FRWC to review and determine proper placement. A public hearing on the amendment to Sub-section (a) of Section 15-6 of Chapter 15 of the Code of Ordinances re-defining the width of such zones and establish a six (6) feet [at pool stage (i.e. lake level at 16 ft.MSL)] buoy protection on the North and South Flats of False River was held, and the amendment passed by the PCPJ on September 25, 2012. The amendment became effective in late October and new GIS locations of the buoys were provided to the Kiwanis Club for relocation. It is expected that the buoys will be relocated during the spring 2013. This will reduce boat traffic and turbidity in the North and South Flats, and provide low wake areas for recreational fishing. The Kiwanis Club has funded and maintained the lakes buoys on a voluntary basis for many years. They are currently replacing the buoys damaged/losed during the flood of 2016.

### ***3.2.10 Education and Outreach***

Documents and presentations have been placed on the False River Ecosystem Restoration Initiative site on the LDNR web site along with FRWC agendas and minutes, news articles and frequently asked questions. The website is updated with a list of actions completed and in progress. Press releases are issued as actions are taken. E-Mails, flyers and talks at various nonprofit meetings are held to keep communities informed. Information generated by agencies or obtained to date has been placed on the LDNR website and the Pointe Coupee Police Jury. The URLs are as follows:

LDNR <http://dnr.louisiana.gov/index.cfm?md=pagebuilder&tmp=home&pid=924>

PCPJ <http://www.pcpolicejury.org/FalseRiverRestoration.aspx>

## **4. Funding Strategies**

### **4.1 Capital Outlay for Ecosystem Restoration**

House Bill 2 (HB 2) approved by the Legislature in the 2012 Regular Session included \$500,000 in Priority 2 funding and \$2.2 million in Priority 5 for the False River Ecosystem Restoration Project. The Bond Commission granted a line of credit at their November 15, 2012 meeting for the priority 2 funds. HB 2 of 2013 moves \$1 million (of the previous \$2.2 million in Priority 5) to Priority 1 with 1.2 million remaining in Priority 5. As of 2017, \$1.8 million has been expended on the project, primarily for the design, permitting and construction of the South Flats Island and \$0.6 million remain available and will be used in Phase 2 of the project. With the additional funds requested in 2017, the project may have available a total of \$2.2 million in 2018 to implement the dredging associated with False River Ecosystem Restoration Project - Phase 2 North Flats. This project funding is critical in order to keep the project moving as scheduled.

### **4.2 False River Restoration Fund**

The False River Restoration Fund was established with the help of the Baton Rouge Area Foundation as a repository for monetary donations from individuals, groups, industry, other Foundations and businesses interested in the work being done to restore and enhance False River and its surrounding watershed and habitat. The Fund is a vital part of the coalition of citizens, local governments, Federal Agencies and State Agencies working to implement House Concurrent Resolution 123 of the 2012 Regular Session of the Louisiana Legislative. The Fund may be used to pay for services and materials to further the restoration of the watershed and habitat of False River, and to provide matching contributions that are required for state and/or federal funds provided.



### **4.3 Other Funding Opportunities**

The FRWC is continuing to pursue funding avenues to ensure that the management strategies proposed in this report are implemented and that a plan to maintain the improvements is set in motion. In 2012, LDNR submitted on behalf of the PCPJ a request to the Apache Corporation for a tree planting and habitat restoration program. The request was not funded by the Apache Corp. program this year. A grant application will be prepared and submitted to Apache Corp. in the next grant cycle and additional partners for habitat improvement will be identified. Similarly, in 2012 LDNR approached the Baton Rouge Green Foundation to find out whether it could provide trees for the project. Baton Rouge Green Foundation relies on donations to fund their efforts and concentrates its efforts in East Baton Rouge Parish. They did offer to potentially conduct a reduced-price tree sale as a source of tree, and/or to potentially work with a Pointe Coupee area donor (if donors can be identified) as a way to promote tree planting. In addition, a NRCS grant application for channel landowners to reduce erosion was identified as a funding mechanism. NRCS has received four applications for EQIP for livestock producers within the Island portion of the False River Watershed. These applications are for fences, waterlines, water troughs, and heavy use area protection. FRWC proposes to remain in contact with state agencies such as LDEQ and LADF for 319/NPS, and LDH to seek future funding for the False River watershed, and to pursue partnership with local industries and other stakeholders.

The False River Nitrogen Impact Mitigation Project was funded by Louisiana Generating LLC. Through savings during the project and reduction of the scope of work associated with access difficulties, funds remained available that may be used for further nitrogen reduction and/or maintenance. With approval of the different stakeholders, these funds have been allocated to future drainage channel maintenance planning and implementation. In order to make this possible, the agreement between Louisiana Generating LLC, the Baton Rouge Area Foundation and the Pointe Coupee Police Jury has been extended and additional five years (through October, 2022).

## **5 Recommendations**

This plan takes a multifaceted approach to address issues within the watershed, including engineered, education, enticement and enforcement solutions. The plan draws from the expertise of many parish, state and federal agencies, including LDNR, LDWF, LDEQ, LDH, LDAF, NRCS, as well as other local stakeholders. The plan also incorporated the findings and recommendations presented in a Feasibility Study previously performed by the USACE. The first solution is to educate the public and parish officials to take a short and long term view of the maintenance of aquatic habitat and water quality of the lake. This requires the stakeholders to voluntarily maintain and/or modify their shoreline, bulkhead, sewerage system, land-use/farming practices and runoff in a manner consistent with best management practices. These common sense activities would be achieved through community information releases and outreach. The

second solution would be to provide enticement to stakeholders not readily willing or able to make limited modifications to their property in the form of available material, and other non-monetary assistance, and assist landowners in taking full advantage of programs supported by the state, the U.S. government and others. Finally, to prevent future deterioration of the lake shoreline, fisheries, aquatic habitat and water quality, implementation and enforcement of new ordinances will be sought to address these shortcomings.

The previously mentioned solutions address small scale issues that can be dealt with at the property level. For watershed implemented hydromodifications of channels, canals and sediment trap, and the South Flats Island will need to be monitored and maintenance performed. It is also recommended that the continued use of a more natural fluctuation of the lake level will be beneficial over the long term. In addition, these changes will need to be maintained in the long term by the PCPJ using BMPs.

Specifically, the plan continues to recommend the installation and maintenance of the such measures/solutions as the following: artificial reefs to provide cover for sportfish; gravel spawning beds; aquatic and shoreline vegetation planting; hydromodification of drainage channels to provide for sediment retention; vegetation buffer/filter zone, grassed bench, as well as other vegetative edge/riparian habitats within the watershed to improve water quality; retarding surface water runoff and stream flow by drainage network modification to provide for flood control; redesign and modification of bulkheads and piers to provide for wave attenuation; continued stocking of sportfish; maintaining the commercial fishing season to harvest roughfish stock; and the promulgation of ordinances to address future physical changes in the watershed. The plan also recommends long term monitoring of the lake's health and evaluates progress associated with the proposed mitigation efforts. Sediments removal and sequestration in the South Flats Island has provided direct benefit for that portion of the lake. It is paramount that the North Flats now be addressed to remove those sediments and provide for improved water quality in that portion of the lake.

The solutions described in this report compliment the ongoing effort to maintain and improve the lake currently underway by the PCPJ, state agencies and others. The PCPJ has been maintaining the M-1 Canal sediment basin, as well as with the assistance of the NRCS and local landowners, making improvement along drainage canals. In addition, the PCPJ, as part of their Master Drainage Plan, has made numerous drainage improvements along The Island road and the Bayou Sere outfall. Local legislators have secured a line of credit from State Capital Outlay to continue engineering and construction of aquatic habitat, artificial reefs and spawning beds. Efforts have been made to secure donations to restore shoreline vegetation and create artificial reefs. The FRWC is pursuing partnership with local industries, NRCS and landowners to further improve drainage canals and the overall hydrology of the watershed. A study and flow model of the M-1 and M-2 Canals, Discharge Bayou, False Bayou and the Chenal, funded through the LDNR and Louisiana Generating LLC, has completed, resulting in the construction of several

hydromodifications within the watershed. Recent monitoring results by the LDEQ, LDWF and others are being used to establish a baseline to evaluate future progress.

## **6 References**

GEC, 2012, Interim Draft Feasibility Report and Environmental Assessment False River Aquatic Ecosystem Restoration Pointe Coupee Parish, Louisiana: Interim draft report prepared by GEC for the U.S. Army Corps of Engineers New Orleans District, 3 volumes.

LDNR and LDWF, 2012, False River Watershed Interim Report on HCR 168 of 2011 Regular Legislative Session: Report prepared by LDNR and LWDF, March 2012, 21 pp. with appendices.

LDNR and LDWF, 2012, Draft Alternative Action Plan False River Ecosystem Restoration Project: Draft action plan prepared by LDNR and LWDF, May 2012, 7 pp.

Lind, Owen T., 1979, Handbook of common methods in Limnology, 2nd edition: C.V Mosby Co. St. Louis, MO.

Reid, George K. and Wood, Richard D., 1976, Ecology of Inland Waters and Estuaries, 2nd ed.: Van Nostrand Company, New York, NY, 485pp

USEPA, 2009, National Lakes Assessment: A Collaborative Survey of the Nation's Lakes: EPA 841-R-09-001.

**Appendix A**  
**Watershed Modeling Report**

# **FALSE RIVER NITROGEN IMPACT STUDY: M-1 AND M-2 CHANNELS, FALSE BAYOU, AND EAST LATERAL**

Report detailing data collection, modeling effort, and recommendations for the False River Nitrogen Impact Study, prepared for Professional Engineering Consultants Corporation by C.H. Fenstermaker & Associates, L.L.C.



April 12, 2016



The False River Watershed Study was prepared for Professional Engineering Consultant Corporation (PEC) by C.H. Fenstermaker & Associates, L.L.C.

False River is a 3,000-acre oxbow lake formed from the Mississippi River in Pointe Coupee Parish with a watershed of approximately 37,000 acres. Fisheries, vegetative habitat, and overall water quality have been in decline since the 1980s. The Louisiana Department of Natural Resources, the False River Watershed Council, Chutz Surveying, PEC, and local residents teamed with the Water Resources group at C.H. Fenstermaker and Associates, L.L.C. to collect hydrologic data, analyze the existing drainage system, and recommend channel modifications to reduce nitrogen transport into False River.

Fenstermaker collected water level and turbidity data over a three-month period, collected water samples for nitrogen, phosphorous, and chlorophyll, developed an existing conditions model, and evaluated several alternatives for nitrogen mitigation. This report details the data collection and modeling effort for the Nitrogen Impact Study.

## TABLE OF CONTENTS

INTRODUCTION .....	1
Summary of False River Watershed Study .....	1
Nitrogen Impact Study .....	3
METHODS .....	3
Hydrology Models .....	3
Hydraulic Models .....	5
Model Calibration and Validation .....	7
Data Collection .....	7
CHANNEL MODIFICATIONS .....	16
Weirs .....	16
Baffles .....	16
Channel Terracing .....	16
Riparian Buffers .....	16
Modeling Results .....	17
RECOMMENDATIONS .....	20
Maintenance .....	20
CONCLUSION .....	20
BIBLIOGRAPHY .....	21

## APPENDICES

- Appendix A - Figures
- Appendix B - Time of Concentration

## LIST OF TABLES

Table 1: Sub-Watershed Areas .....	3
Table 2: Soil Table .....	5
Table 3: Collected and Processed Data Statistics .....	11
Table 4: Collected and Processed Turbidity Statistics .....	11
Table 5: Location 1 Sample Results .....	14
Table 6: Location 2 Sample Results .....	14
Table 7: Location 3 Sample Results .....	14
Table 8: EPA's Numeric Nutrient Water Quality Criteria for Florida....	15
Table 9: Chlorophyll A Sample Results .....	16

DRAFT



## LIST OF FIGURES

- Figure 1: False River Watershed and Channel Network
- Figure 2: False River Watershed Basins
- Figure 3: False River Soil Types
- Figure 4: False River Land Use Types
- Figure 5: False River Curve Numbers
- Figure 6: Nitrogen Impact Study Survey Points
- Figure 7: False River LIDAR Data
- Figure 8: False River Channel Flow Direction
- Figure 9: False River Channel Comparisons
- Figure 10: False River Channel Cross Sections
- Figure 11: False River Channel Cross Section Locations
- Figure 12: Modeled Water Level Comparisons
- Figure 13: Modeled Water Level Comparison Locations
- Figure 14: M-2 and False Bayou Water Level and Turbidity Levels
- Figure 15: Water Level - Turbidity Comparison
- Figure 16: Data Collection Locations
- Figure 17: Sampling Location 1: The Sandbar
- Figure 18: Sampling Location 2: Pointe Coupee Parish Museum
- Figure 19: Sampling Location 3: Satterfield's Landing
- Figure 20: Recommended Channel Modifications
- Figure 21: Discharge Plots
- Figure 22: Typical Weir Cross-Section
- Figure 23: Typical Baffle Cross-Section
- Figure 24: Typical Terracing Cross-Section
- Figure 25: Storage Area Locations

DRAFT

DRAFT

### SUMMARY OF FALSE RIVER WATERSHED STUDY

The predisposition for a disconnected oxbow lake to remain a deep water body can be jeopardized by high watershed erosion rates resulting in large volumes of sedimentation during runoff events. Erosion can be broadly classified into two categories: natural or accelerated erosion. Natural erosion “results from tectonic uplift, earthquakes, weathering, and chemical decomposition and the long-term action of water, wind, gravity, and ice” (Garcia, 2008). Accelerated erosion is the result of human factors (anthropogenic) such as agricultural activities, urbanization, mining activities, and river regulations (Garcia, 2008).

Atmospheric deposition of nitrogen can have many negative effects on the environment, such as nutrient imbalances that lead to eutrophication or algal blooms in many ecosystems (Swackhamer, et al, 2004).

Agricultural activities are a primary anthropogenic factor initiating erosion in lakes, and the Mississippi Delta is a prime agricultural region due to a hot, humid climate and long growing season. The conditions conducive to prolific crops are responsible for the survival of weeds and pests causing agricultural lands in the region to rely on agrochemical pest control. These agrochemicals are often transported into nearby lakes during runoff events, further reducing water quality (Leonard, 1988). Combined with increased sedimentation due to agriculturally accelerated erosion, many delta oxbow lakes that were historically known for their fish productivity and recreational value are facing challenges with declining water quality and clarity.

In addition to nutrient influx, elevated suspended sediment levels can further impact the biodiversity of water bodies in many ways. Suspended sediments can increase turbidity levels making it more difficult for light to penetrate the water column. Subsequently, high turbidity levels limit photosynthesis jeopardizing the survival of submerged aquatic vegetation and restricting the production of phytoplankton in the water column. High turbidity levels also reduce respiratory capacity of aquatic invertebrates and limit the feeding ability of visual predators and filter feeders (Tetra Tech, 2003). As sediment is deposited on the bed of water bodies, overall depth and habitat complexity is reduced as voids and pools are filled. Sediment deposited on shell beds may cover the substrate used by fish and invertebrates for egg placement and can bury benthic plants and

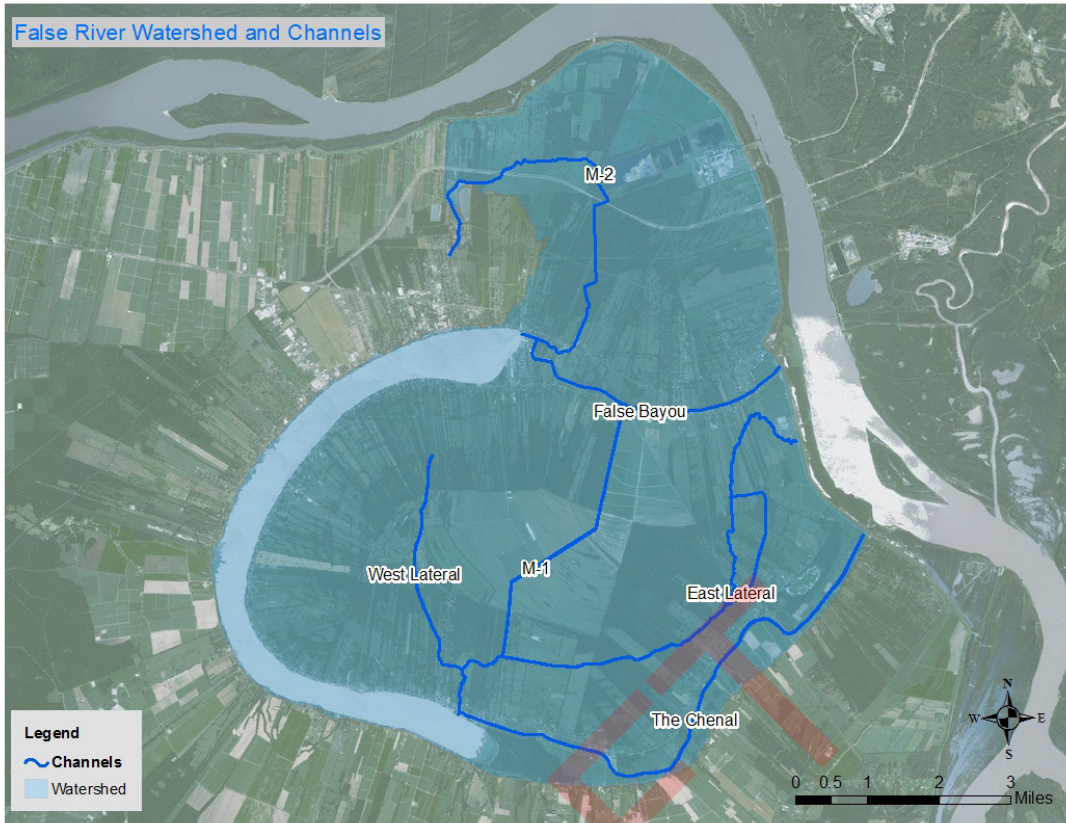

Figure 1 - False River Watershed and Channel Network

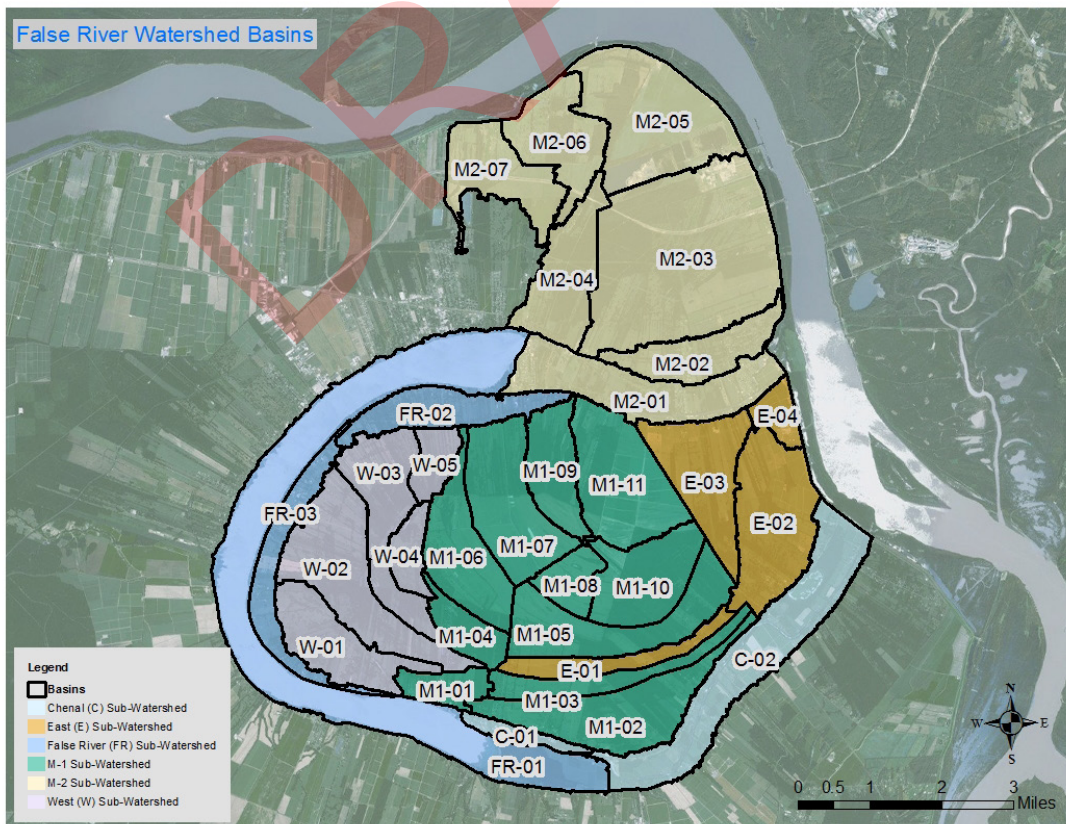

Figure 2 - False River Watershed Basins

animals (Phillips, 2005). Finally, sediment can transport toxic materials (e.g. heavy metals, pesticides, herbicides), potential pathogens, and nutrients further contaminating receiving waterbodies.

The False River ecosystem has been in decline for decades, seemingly due to high sediment and nutrient loads. The most recent US Environmental Protection Agency (EPA) Waterbody Report in 2010 declared False River as Impaired for fish and wildlife propagation. High pH levels from unknown sources and the introduction of non-native aquatic plants have been the cause of impairment according to the EPA (US EPA, 2010). Data collected for the Louisiana Department of Environmental Quality (LDEQ) report in 2003 indicated the lake was experiencing organic enrichment (LDEQ, 2003). While these findings are from nearly a decade ago, they are presumed applicable today, as evidenced by common algal blooms and a “pea-green” water color. This conclusion also correlates with the 2010 LDEQ findings, as high pH levels are common in waters with algal blooms.

False River was disconnected from the Mississippi River by levees beginning in the 1930s. The 3,000 acre oxbow lake drains approximately 36,000 acres, which eventually enters the Atchafalaya Basin. By the 1970s, nearly 75% of the False River watershed was converted to agricultural lands and channels were constructed to efficiently drain the watershed. Water quality in False River began to decrease and the Environmental Protection Agency (EPA) classified False River as eutrophic in 1977 and impaired in 2010.

Fisheries, vegetative habitat, and overall water quality have been in decline since the 1980s. Data was collected and analyzed over a six-month period beginning in October 2012 and an existing conditions model was developed by delineating basins, collecting rainfall data, and determining land use. Channel hydromodifications were recommended to reduce sediment transport into False River. The results of the sediment study were

published in The False River Watershed Study (LA DNR, False River Watershed Council, C.H. Fenstermaker & Associates, L.L.C., 2013).

## NITROGEN IMPACT STUDY

Non-point source pollution is “linked to eutrophication, decline in fish population, and reduced depth in oxbow lakes.” (Knight, 2015) The nitrogen mitigation study augments the previous study by analyzing nitrogen levels and evaluating methods to reduce nitrogen loads entering False River. Water level and turbidity data was collected over a three month period and an existing conditions model was developed by delineating basins, collecting rainfall data, and determining land use. Nitrogen, phosphorous, and chlorophyll readings were taken once every three months by C.H. Fenstermaker & Associates, L.L.C. — this data will continue to be collected through 2018.

## METHODS

Approximately 36,500 acres (57.1 square miles) drain into False River through 35 miles of main channels (*Figure 1*). Fenstermaker developed hydrology models using HEC-HMS v.4.0 and hydraulic models in HEC-RAS v.4.1.0. The hydrologic and hydraulic models were used to determine existing channel flow parameters and analyze the hydraulic impact of nitrogen reduction alternatives using collected water level and turbidity data.

## HYDROLOGY MODELS

The HEC-HMS hydrology models were developed by delineating basins, collecting rainfall data, and determining land use. Three specific storm events were modeled: 2-year, 24-hour; April 15, 2015; and May 26, 2015. The 2-year storm event represents 4.8 inches of rain over 24 hours. On April 16, approximately 0.7 inches fell over 24 hours. On May 26, approximately 2.2 inches fell over 24 hours.

For this study, the False River watershed was delineated into six sub-watersheds and 32 basins as shown in *Figure 2*. *Table 1* lists sub-watershed areas and runoff volume during a 2-year, 24-hour storm event. The M-1 and M-2 sub-watersheds show the largest runoff volumes mainly due to their large contributing area compared to the other sub-watersheds, while the Chenal and East sub-watersheds show the smallest runoff volumes. Detailed attributes for each basin are located in *Appendix B*.

**Table 1: Sub-Watershed Areas**

Sub-watershed	Area (acres)	Runoff Volume (acre-ft)
Chenal	2,248	622
East	3,415	1,008
False River	5,879	1,793
M-1	9,886	2,920
M-2	10,803	3,292
West	4,324	1,275

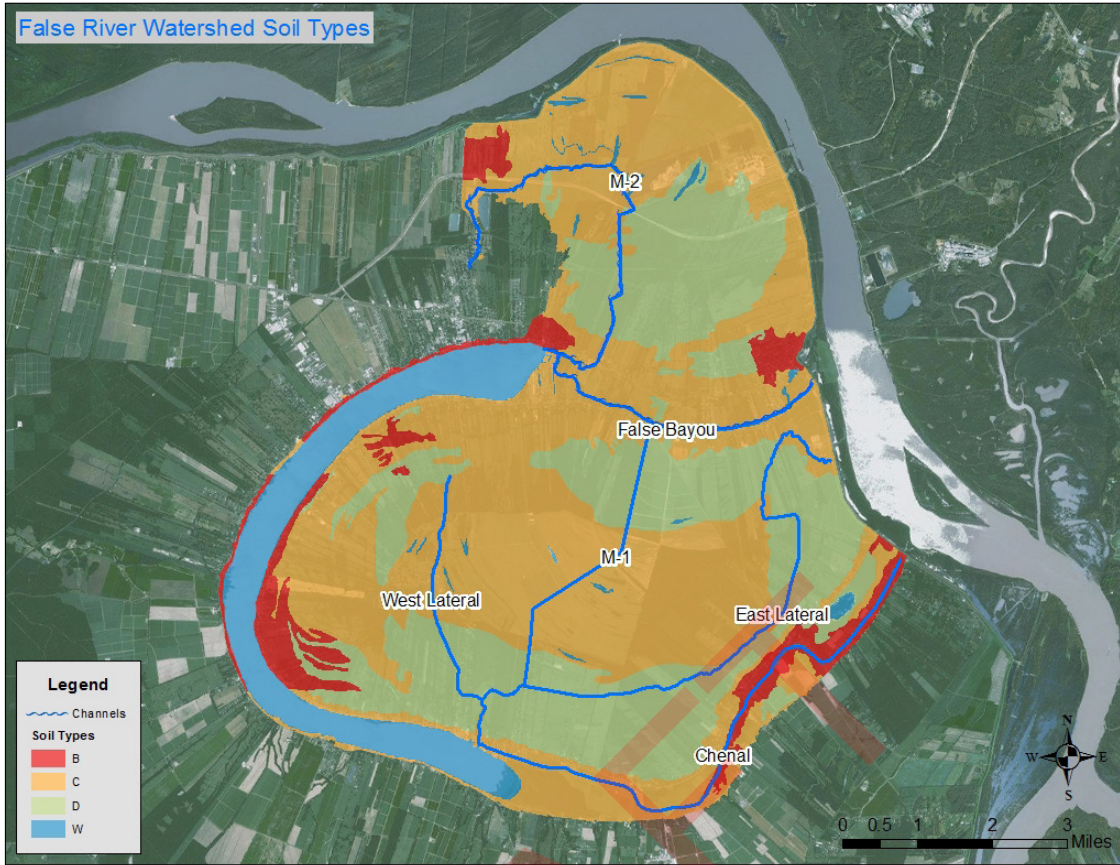

Figure 3 - False River Soil Types

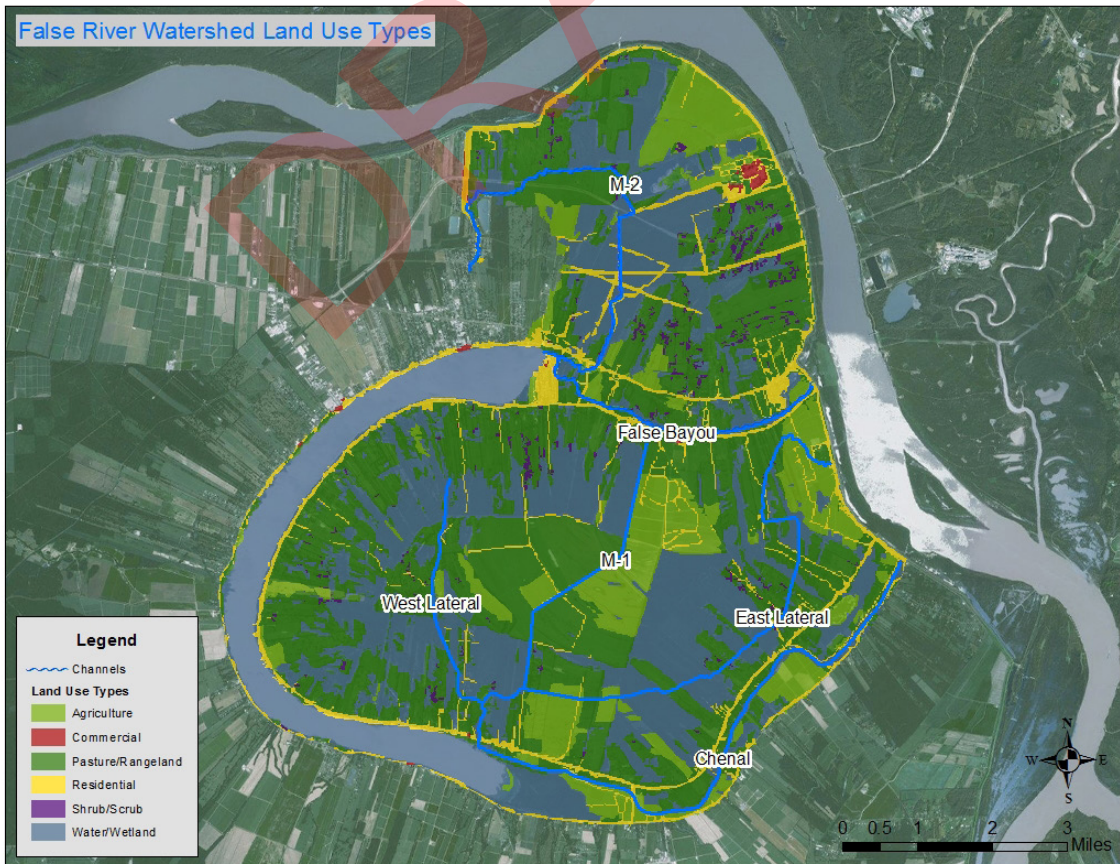

Figure 4 - False River Land Use Types

Table 2: Soil Table	
<b>Group A:</b>	low runoff potential, high infiltration rates even when thoroughly wetted, and consist chiefly of deep, well drained sand or gravel
<b>Group B:</b>	moderate infiltration rates when thoroughly wetted and consist chiefly of moderately deep, moderately well drained soils with moderately fine to moderately coarse textures
<b>Group C:</b>	low infiltration rates when thoroughly wetted and consist chiefly of soils with a layer that impedes downward movement of water and soils with moderately fine to fine texture
<b>Group D:</b>	high runoff potential, very low infiltration rates when thoroughly wetted, and consist chiefly of clay soils with a high swelling potential, soils with a permanent high water table, soils with a claypan or clay layer at or near the surface, and shallow soils over nearly impervious material

Figures 3 through 5 show soil types, land use designations, and Curve Numbers for the False River watershed. Approximately 85 percent is classified as soil types C and D (52 percent and 32 percent, respectively) which typically consist of clays, silts, and loams showing poor infiltration and high runoff potential (USDA NRCS, 2007). See Table 2 for more detailed descriptions of soils. The majority of the land use in the watershed is agricultural and pasture (39 percent and 13 percent) with limited areas of residential and commercial uses (approximately eight percent). The Curve Numbers ranged between 95 and 56 with an average of 82. Curve Number (CN) is a method of estimating the approximate runoff volume from a rainfall event. CN is determined by the USDA National Resources Conservation Service (NRCS) TR-55 Method, which uses land use and soil types to estimate runoff. Overall, the watershed shows poor infiltration as a result of consisting of predominantly Type D soils which results in high runoff potential coupled with large areas of agriculture and pasture lands.

### HYDRAULIC MODELS

The HEC-RAS hydraulic models were developed using survey data, field visits, and water levels collected as a part of a project-specific monitoring program. These

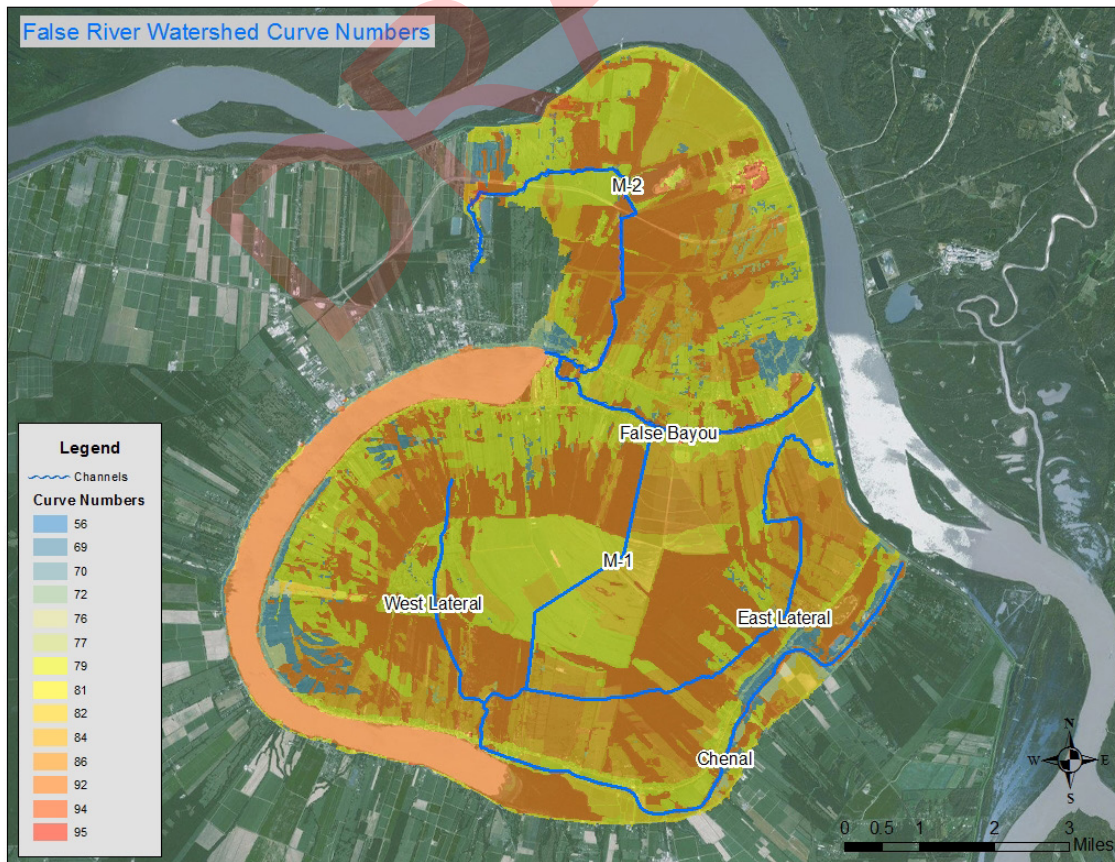

Figure 5 - False River Curve Numbers



Figure 6 - Nitrogen Impact Study Survey Points

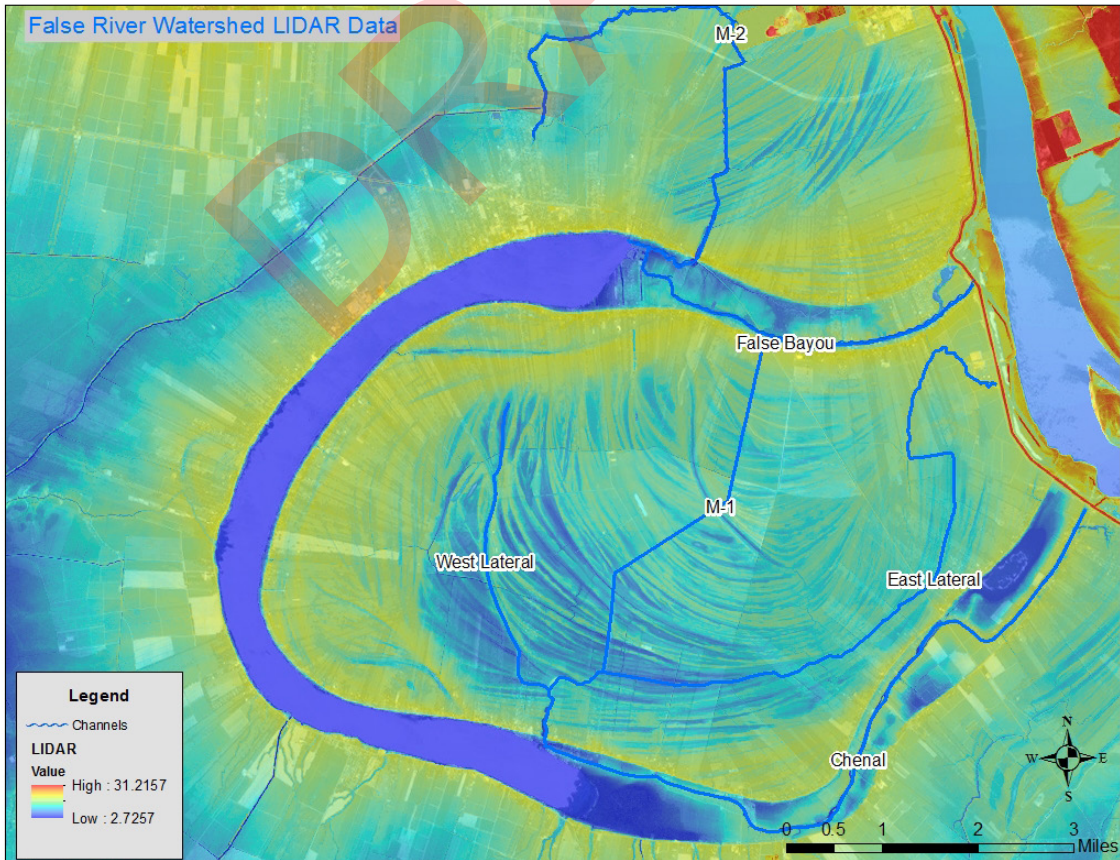

Figure 7 - False River LIDAR Data



models replicated water level, discharge, and velocity along the studied channels. Discharges from HEC-HMS were linked to HEC-RAS to replicate existing conditions and proposed alternatives.

Chustz Surveying, Inc. provided topographic and bathymetric data along the M-1 Channel, M-2 Channel, False Bayou, and the East Lateral in addition to the previously surveyed locations along the Chenal, East Lateral, M-1 Channel, and West channels in addition to bathymetric data in the north and south flats of False River (Figure 6). Light Detection and Ranging (LIDAR) data from LSU Atlas was used to complete the topographic surface (Figure 7). The cold colors (blues) represent low-lying areas and the hot colors (reds) are higher ground.

The M-2 and False Bayou Channel are the two major drainage systems that discharge into the northern part of False River. Combined, they drain approximately 10,800 acres into False River. As shown in Figure 9, the M-2 Channel is approximately 2.5 miles longer than False Bayou. Surveyed channel dimensions are shown in Figure 10. The locations for these surveyed channels are shown in Figure 11. The channel area increases and elevation decreases downstream along the M-2 Channel, while False Bayou has its highest elevation occurring at the center of the channel. The channel slopes and dimensions

suggest the M-2 Channel has a higher velocity than False Bayou.

## MODEL CALIBRATION AND VALIDATION

The hydrologic and hydraulic models were calibrated using storm events on April 16, 2015 and May 26, 2015. Spatially and temporally varying rainfall data from the National Climatic Data Center and False River water levels from Pointe Coupee Parish were used to calibrate the models. As shown in Figure 12, the models accurately replicated existing conditions. See Figure 13 for Modeled Water Level Comparison Locations.

## DATA COLLECTION

Water level and turbidity data were collected using YSI data sondes, and hand collected water samples were analyzed by Entek Environmental Laboratories, Inc. and the Wetland and Aquatic Biogeochemistry Lab at the Department of Oceanography and Coastal Sciences in the School of Coast and Environment at Louisiana State University.

Data sondes collected water level and turbidity data at Gosserand Road along the M-2 Channel and Legion Road



Figure 8 - False River Channel Flow Direction

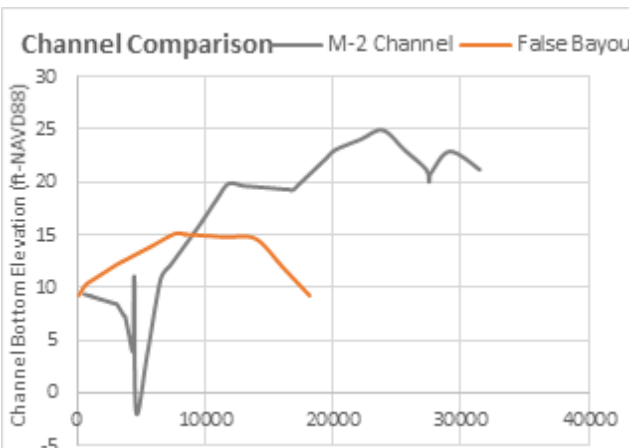
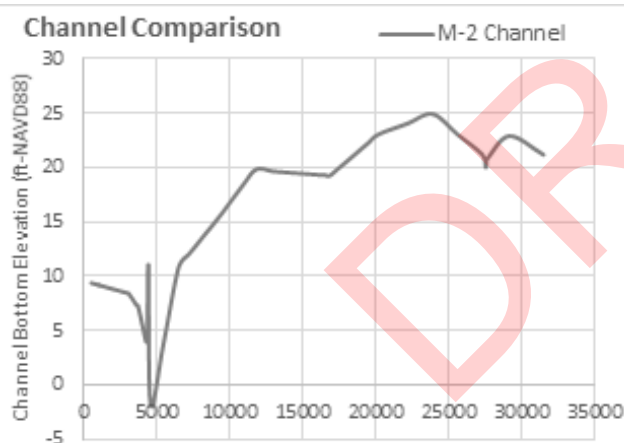
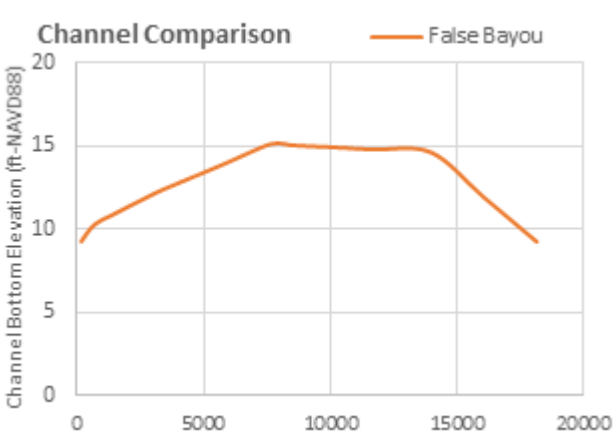
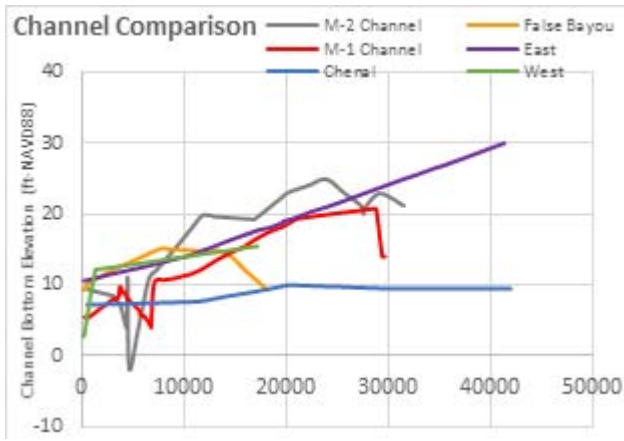

Figure 9 - False River Channel Comparisons

along False Bayou (Figure 13) on a continuous hourly interval. The collection period spanned from April 10, 2015, through July 5, 2015. Figure 14 shows processed water level and turbidity readings for each location. Turbidity is used in the model as a surrogate for nutrients concentrations or indicating a change in water quality.

Gosserand Road and Legion Road generally showed similar water levels indicating that water levels in False Bayou are heavily influenced by the M-2 Channel and False River water levels. False Bayou displayed higher peak turbidity levels, while the M-2 did not vary as much; however, the M-2 Channel demonstrated larger turbidity values.

As shown in Tables 3 and 4, water levels were generally similar along the M-2 and False Bayou, whereas turbidity readings were higher along the M-2 Channel. Water levels averaged 14.4 feet along the M-2 and 14.3 feet along False Bayou. Turbidity values are generally highest along the M-2 Channel which averaged 102 NTU, while turbidity readings along False Bayou, which averaged 32 NTU, are typically lower. The data suggests the False Bayou small sub-watershed does not produce large stormwater runoff volumes and the system is largely controlled by the M-2 Channel.

The relationship between water level and turbidity was variable. Turbidity typically peaked as the water levels increased, however turbidity peaked as the water levels receded on several occasions (Figure 15).

This data collection effort spanned three months and only provides a short glimpse of long-term water level and turbidity trends along the M-2 Channel and False Bayou. Furthermore, the drawdown of False River occurred from September 2, 2014 to May 1, 2015. The irregular relationship between turbidity and water level could be the result of variability in the interaction of multiple factors (e.g., agricultural tilling, land clearing, shoreline development, etc.).

Water quality sampling conducted by C.H. Fenstermaker & Associates, L.L.C. and testing is an ongoing effort which spans four years (February 2015 to February 2019) and occurs on a quarterly basis. The water samples are collected at three sites along False River (Figure 16). Sampling location number one is The SandBar on False River Road, which is the most southern location and for testing purposes is also known as location B1/B2 (Figure 17). The second sampling location is The Pointe Coupee Parish Museum, which is located in the middle of False River and for testing purposes is also known as location

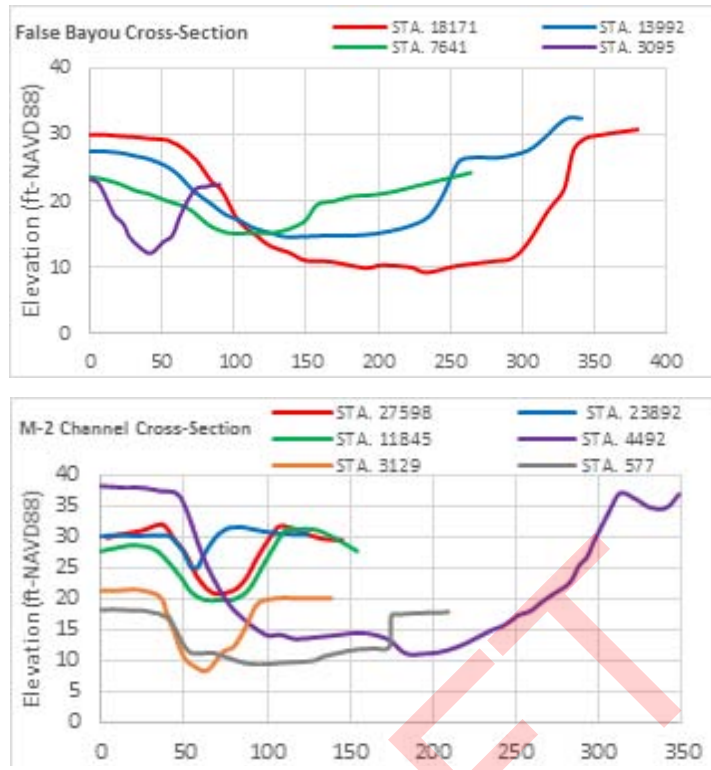

Figure 10 - False River Channel Cross Sections

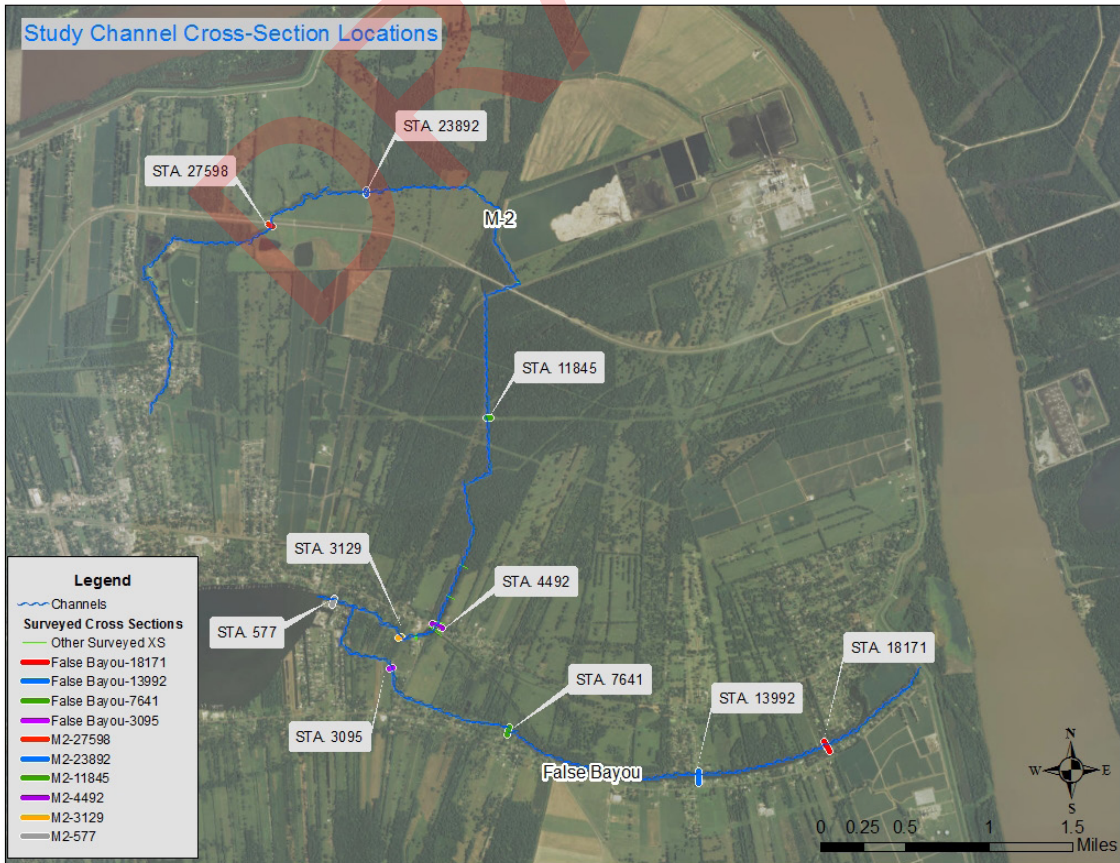

Figure 11 - False River Channel Cross Section Locations

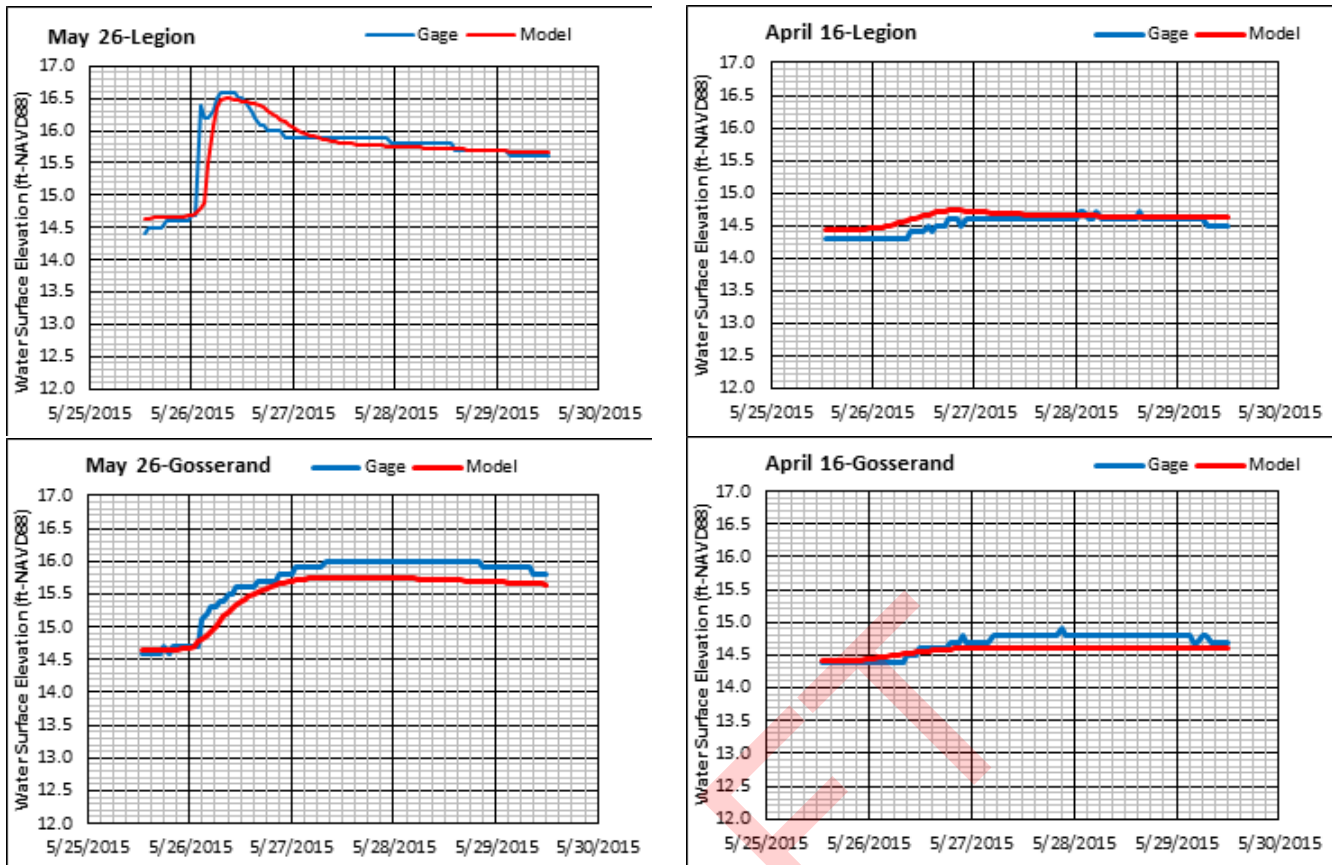

Figure 12 - Modeled Water Level Comparisons

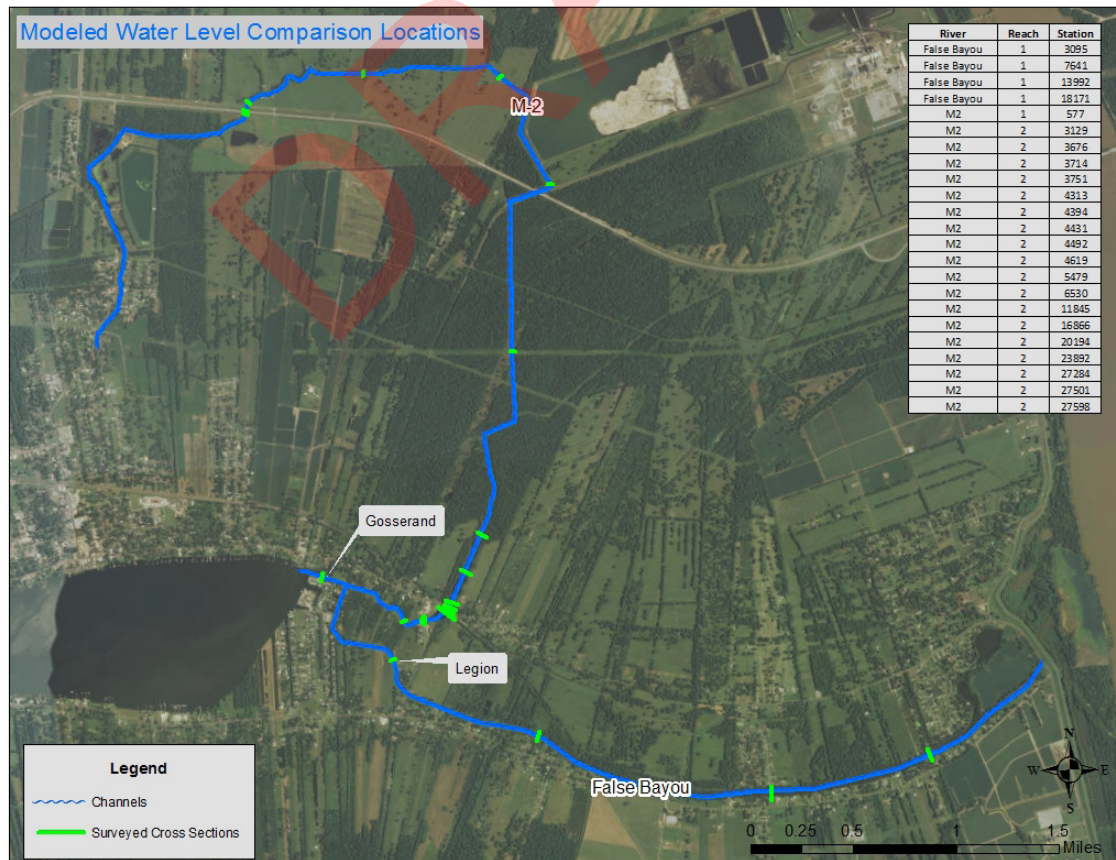

Figure 13 - Modeled Water Level Comparison Locations

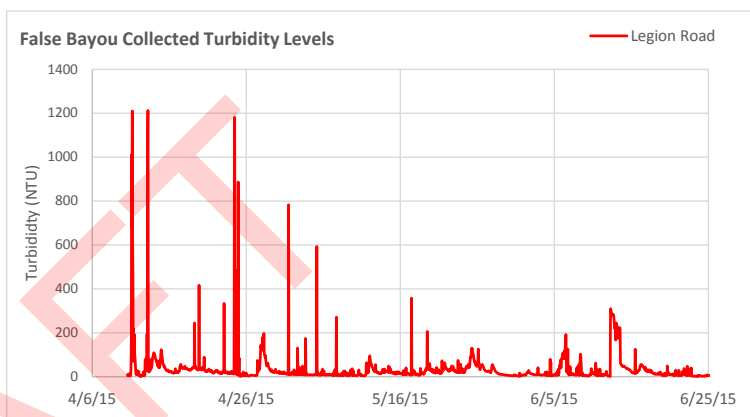
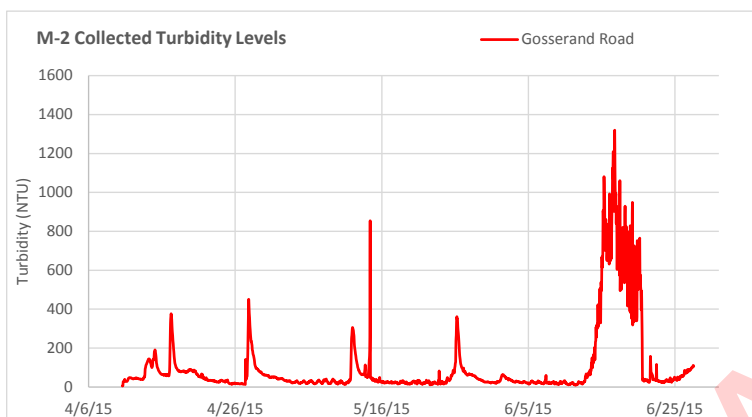
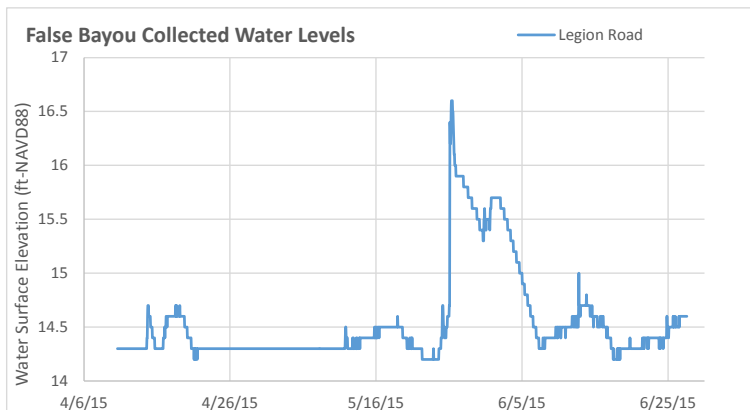
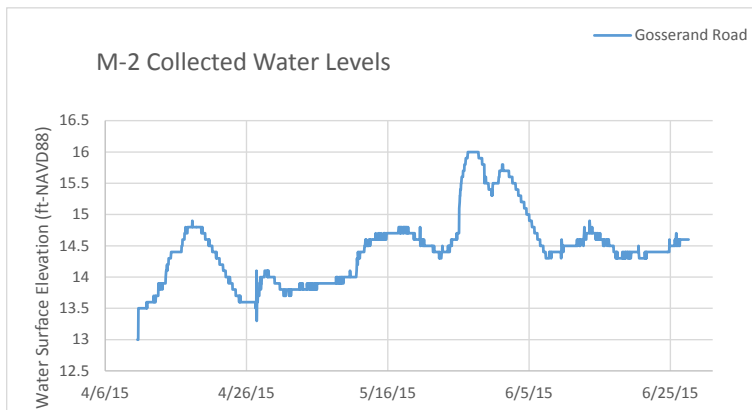

Figure 14 - M-2 and False Bayou Water Level and Turbidity Levels

Table 3: Collected and Processed Data Statistics					
Data Sonde	Location	Water Level (ft-NAVD88)			
		# of Readings	Maximum	Median	Minimum
1	M-2: Gosserand Road	1,873	16.0	14.4	13.0
2	False Bayou: Legion Road	2,065	16.6	14.4	14.2

Table 4: Collected and Processed Turbidity Statistics					
Data Sonde	Location	Turbidity (NTU)			
		# of Readings	Maximum	Median	Minimum
1	M-2: Gosserand Road	1,873	1,319.8	34.7	5.1
2	False Bayou: Legion Road	2,065	1,212.2	16.9	1.5

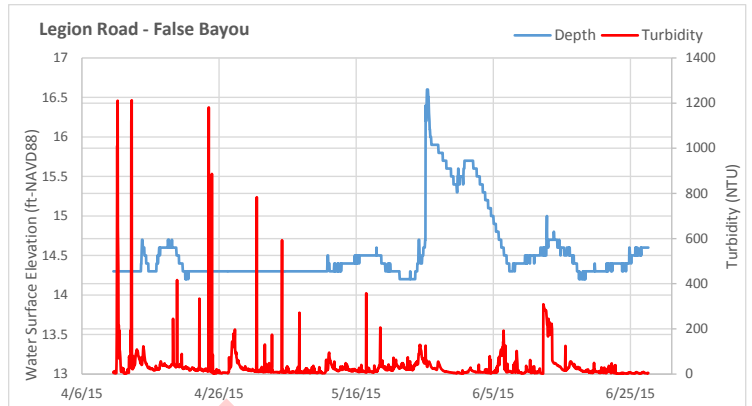
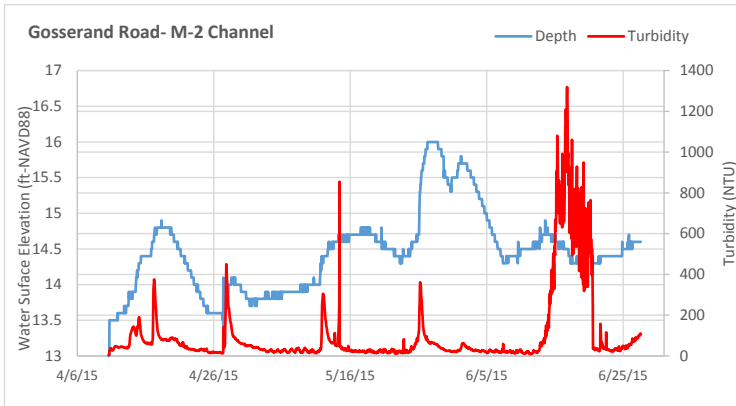

Figure 15 - Water Level - Turbidity Comparison

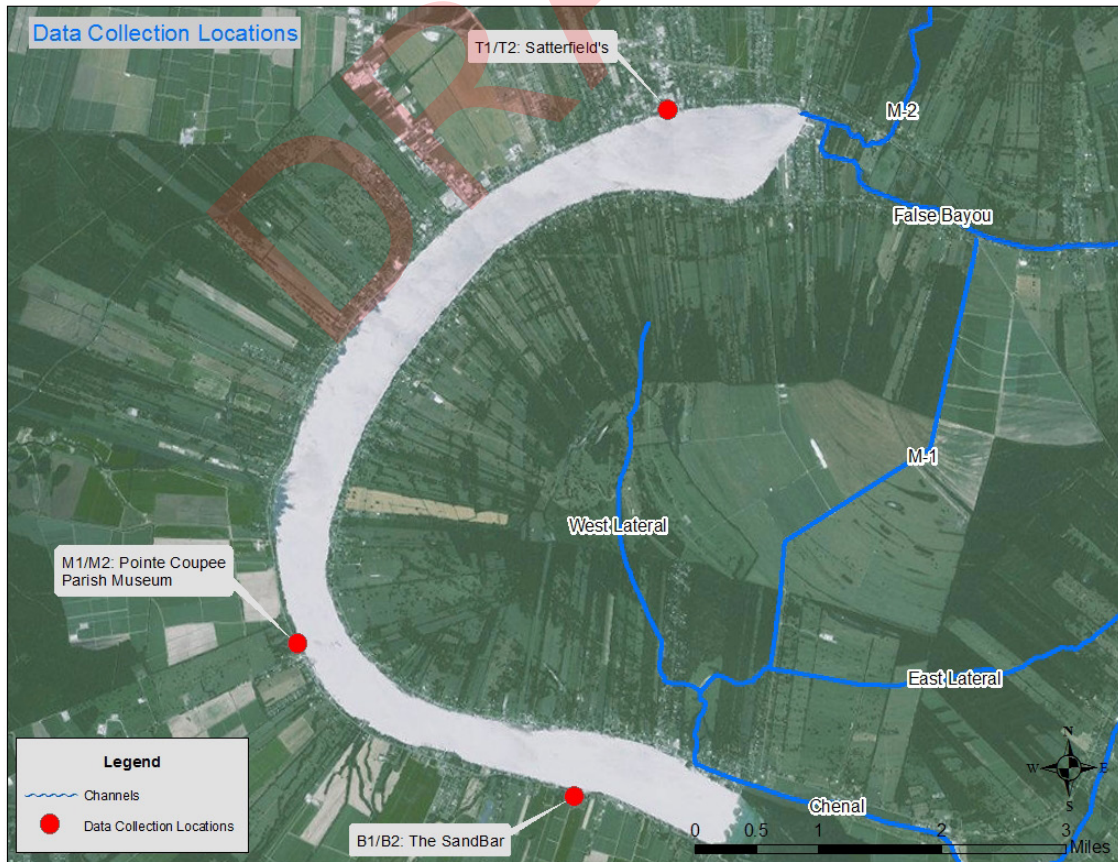

Figure 16 - Data Collection Locations



Figure 17 - Sampling Location 1: The Sandbar



Figure 18 - Sampling Location 2: Pointe Coupee Parish Museum



Figure 19 - Sampling Location 3: Satterfield's Landing

**Table 5: Location 1 Sample Results**

Date	Description	B-1 Concentration (mg/L)				B-2 Concentration (mg/L)			
		Total Kjeldahl Nitrogen-N	Nitrate-Nitrite-N	Total Nitrogen	Total Phosphorous	Total Kjeldahl Nitrogen-N	Nitrate-Nitrite-N	Total Nitrogen	Total Phosphorous
2/25/15	2015-Q1	0.60	1.00	0.60	0.05	0.60	1.00	0.60	0.05
5/29/15	2015-Q2	1.00	1.00	1.00	0.10	1.10	1.00	1.10	0.10
8/21/15	2015-Q3	1.20	1.00	1.20	0.10	1.40	1.00	1.40	0.10
11/24/2015	2015-Q4	0.70	1.00	0.70	0.10	0.60	1.00	0.60	0.10

**Table 6: Location 2 Sample Results**

Date	Description	M-1 Concentration (mg/L)				M-2 Concentration (mg/L)			
		Total Kjeldahl Nitrogen-N	Nitrate-Nitrite-N	Total Nitrogen	Total Phosphorous	Total Kjeldahl Nitrogen-N	Nitrate-Nitrite-N	Total Nitrogen	Total Phosphorous
2/25/15	2015-Q1	0.60	1.00	0.60	0.15	0.80	1.00	0.80	0.19
5/29/15	2015-Q2	1.20	1.00	1.20	0.10	1.20	1.00	1.20	0.10
8/21/15	2015-Q3	0.60	1.00	0.60	0.10	0.50	1.00	0.50	0.10
11/24/2015	2015-Q4	1.00	1.00	1.00	0.10	0.97	1.00	1.00	0.10

**Table 7: Location 3 Sample Results**

Date	Description	T-1 Concentration (mg/L)				T-2 Concentration (mg/L)			
		Total Kjeldahl Nitrogen-N	Nitrate-Nitrite-N	Total Nitrogen	Total Phosphorous	Total Kjeldahl Nitrogen-N	Nitrate-Nitrite-N	Total Nitrogen	Total Phosphorous
2/25/15	2015-Q1	0.90	1.00	0.90	0.05	0.90	1.00	0.90	0.05
5/29/15	2015-Q2	0.60	1.00	0.60	0.10	0.80	1.00	0.80	0.10
8/21/15	2015-Q3	0.40	1.00	0.40	0.10	0.50	1.00	0.50	0.10
11/24/2015	2015-Q4	0.90	1.00	0.90	0.10	0.80	1.00	0.80	0.10



M-1/M-2 (Figure 18). The final sampling location is Satterfield Landing, which is the most northern location and for testing purposes is known as T1/T2 (Figure 19).

Samples at each location are analyzed by Entek Environmental Laboratories, Inc. for Total Nitrogen, Nitrate-Nitrite-N, Total Kjeldahl Nitrogen-N, and Total Phosphorus. The results of the water testing thus far is located in Tables 5 through 7 and Table 9. Values for Total Kjeldahl Nitrogen-N and Total Nitrogen range from 0.4 to 1.4 with an average value of 0.8, values for Nitrate-Nitrite-N are consistently at 1.0, and values for Total Phosphorous range from 0.05 to 0.19 with an average value of 0.1.

Florida is the only state with specific standards for nutrients in surface water (see Table 8). Using these standards (Total Nitrogen 1.27 mg/L and Total Phosphorous 0.05 mg/L), we can see that False River is below the Total Nitrogen and above the Total Phosphorus. Total Phosphorus concentrations of unpolluted waters are reported to be usually less than 0.1 mg/L (Lind, 1979). Reid and Wood (1976) state that the mean total phosphorus content of most lakes ranges from 0.010 to 0.030 mg/L. All of recently collected samples from False River indicate Total Phosphorus concentrations that exceed 0.1 mg/L. In addition, data reported by LDEQ in 2003 indicate Total

Phosphorus values approximately ten times the values reported by Reid and Wood (1976) as average lake values, which is consistent with the recently collected data.

Samples at each location are also analyzed by the Wetland and Aquatic Biogeochemistry Lab at the Department of Oceanography and Coastal Sciences in the School of Coast and Environment at Louisiana State University for Chlorophyll A. Chlorophyll A is tested to determine the amount of algae present in the lake. Table 9 includes results of chlorophyll testing to date. Values for Chlorophyll A range from 4.299 to 50.4 µg/L. According to National Lakes Assessment (US EPA, 2009), Chlorophyll A levels exceeding 30 µg/L are considered hyper eutrophic, meaning they have higher levels of nutrients and high levels of chlorophyll which can endanger aquatic ecosystems. The average Chlorophyll A value sampled is 18.96 µg/L but the samples collected on August 21, 2015 at the most northern location resulted in elevated readings with an average of 31 µg/L and all samples taken on February 16, 2016 indicate that high levels of Chlorophyll A are present. False River Lake appears to be experiencing organic enrichment. That conclusion is supported by frequent anecdotal observations of significant algal populations, as evidenced by the frequent visible “pea-green” color of the lake water.

**Table 8: EPA’s Numeric Nutrient Water Quality Criteria for Florida**

A	B	C	D	E	F
		Baseline Criteria (mg/L)		Modified Criteria <sup>a</sup> (mg/L)	
	Chlorophyll A (µg/L) <sup>b</sup>	Total Nitrogen	Total Phosphorous	Total Nitrogen	Total Phosphorous
Colored lakes <sup>c</sup>	20	1.27	0.050	1.27-2.23	0.05-0.16
Clear lakes, high alkalinity <sup>d</sup>	20	1.05	0.030	1.05-1.91	0.03-0.09
Clear lakes, low alkalinity	6	0.51	0.010	0.51-0.93	0.01-0.03

<sup>a</sup> If chlorophyll a is below the criterion in column B and there are representative data to calculate ambient-based, lake-specific, modified TP and TN criteria, then DEP may calculate such criteria within these bounds from ambient measurements to determine lake-specific, modified criteria.

<sup>b</sup> Chlorophyll a is an indicator of phytoplankton biomass (microscopic algae) in a water body, with concentrations reflecting the integrated effect of many of the water quality factors that may be altered by human activities.

<sup>c</sup> Colored lakes are distinguished from clear lakes based on the amount of dissolved organic matter they are free from turbidity. Dissolved organic matter concentration is reported in Platinum Cobalt Units (PCU). Colored lakes have values greater than 40 PCU and clear lakes have values less than or equal to 40 PCU.

<sup>d</sup> Alkaline lakes are distinguished from acid lakes based on their concentration of CaCO<sub>3</sub>. Alkaline lakes have greater than 20 mg/L CaCO<sub>3</sub>, while acid lakes have values less than or equal to 20 mg/L CaCO<sub>3</sub>.

Table 9: Chlorophyll A Sample Results	
Sample	Concentration of Chlorophyll A (µg/L)
6/2/2015	
STD 5.5 µg/L	5.4
B1	14.2
B1 Duplicate	15.1
B2	13.2
M1	9.86
M2	8.59
T1	9.51
T2	9.33
T2 Duplicate	8.35
8/20/2015	
STD 5.6 µg/L	5.45
B1	16.41
B2	14.47
M1	5.58
M2	6.01
T1	28.2
T2	30.6
T2 Duplicate	33.8
11/23/2015	
B1	25.1
B2	17.1
M1	4.3
M1 Duplicate	4.299
M2	9.89
T1	6.98
T2	6.3
2/16/2016	
B1	36.2
B1 Duplicate	28.8
B2	25.6
M1	21.0
M2	28.2
T1	50.4
T1 Duplicate	38.8
T2	42.7

## CHANNEL MODIFICATIONS

The hydrologic and hydraulic models were used to evaluate potential channel hydromodifications aimed at reducing nitrogen loads entering False River. Based upon the study completed in June 2013, weirs were selected as the primary recommended alternative due to effectiveness, constructability, and cost. Placing weirs will decrease discharge along channels which will provide nitrogen and sediment reduction. The addition of other channel modifications including baffles, terracing, and riparian buffers would also reduce discharge and provide added nitrogen and sediment reduction.

### WEIRS

Weirs were placed along the M-1 Channel, East Lateral, and the M-2 Channel. The weirs were placed at locations away from residential properties and in areas that are subject to larger nutrient and sediment loading. Weir placement determined effectiveness of discharge reduction. The weirs were overtopped and showed minimal discharge reduction when placed farther downstream on the M-1 Channel and they were not placed in downstream areas of the M-2 due to residential areas that border the channel. Weirs also showed minimal discharge reduction when placed further upstream along the M-2 and were not effective on False Bayou. Weirs were used to increase channel storage duration and reduce channel velocities. The increased channel storage duration would have a greater impact on smaller storm events.

### BAFFLES

Baffles were placed along the M-1 and M-2 Channels to reduce channel velocity and limit discharge. Half of the channel is blocked off, which causes stormwater runoff to flow around the obstructions, thereby reducing discharge.

### CHANNEL TERRACING

Terracing was modeled along the M-2 near Patin Dyke Slough. Channel terracing is an earthen embankment built within the channel to reduce velocity and prevent erosion.

### RIPARIAN BUFFERS

Riparian buffers are highly recommended along the overbanks of the channel to act as filters to remove pollutants, nitrogen, and sediments from stormwater runoff entering False River. The majority of plant materials for the riparian buffers should consist of existing, naturally generated vegetation suitable for the soils and hydrology of the site. The USDA NRCS provides criteria for plant

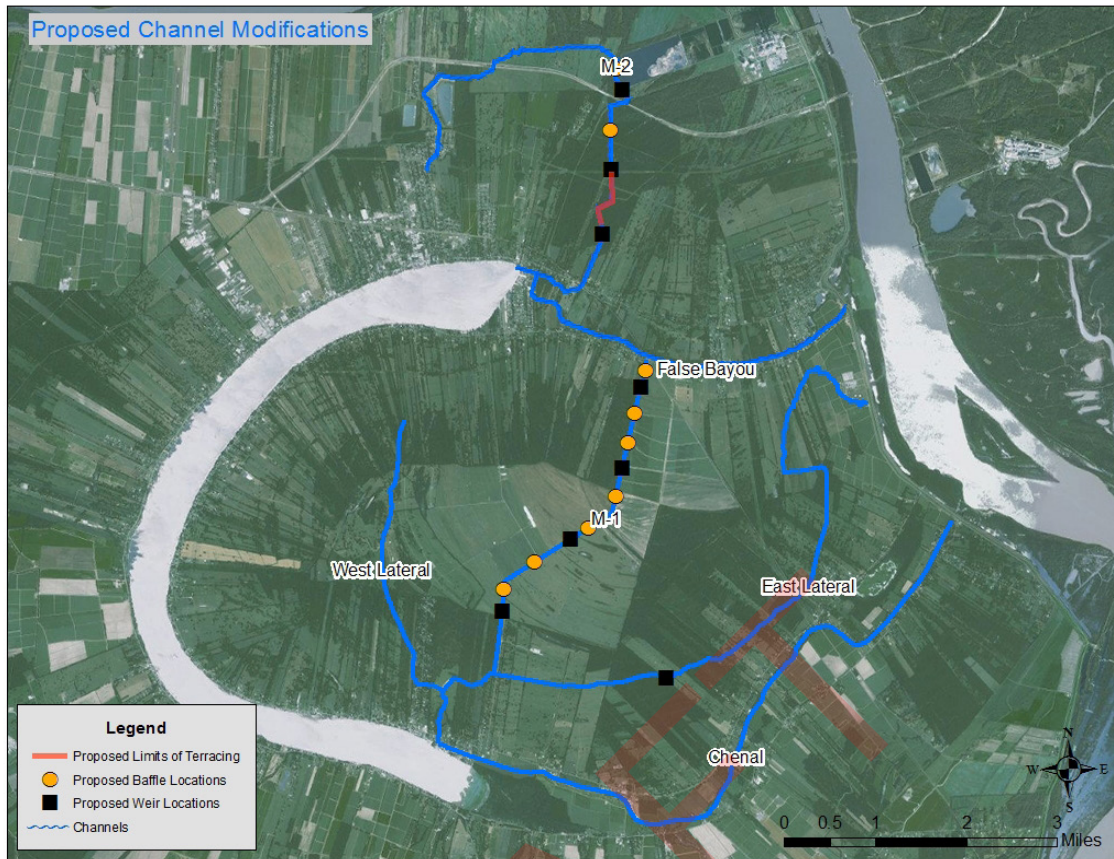

Figure 20 - Recommended Channel Modifications

selection as well as minimum standards for width of riparian zones. Shrubs and trees should be native species which supply multiple values such as wildlife habitat, timber, or aesthetics. The recommended minimum width is 35 feet perpendicular from the normal water line or bank of the channel, with a mix of native grasses and shrubs/trees, to reduce excess amounts of sediment and NPS pollutants (USDA NRCS, 2010). Switchgrass (*Panicum virgatum*) and Bald Cypress (*Taxodium distichum*) are native grasses suitable for buffers and Giant Cutgrass (*Zizaniopsis milacea*) is suitable for channel areas.

The locations of the proposed weirs, baffles, and channel terracing are shown in Figure 20.

### MODELING RESULTS

The nitrogen mitigation measures are most effective along the M-1 Channel as seen in discharge comparison plots (Figure 21). Placement of the weirs and baffles along the M-1 Channel reduced peak discharge by approximately 30 percent for the 2-year, 24-hour design storm. The weirs, baffles, and terracing along the M-2 Channel does not reduce discharge drastically due to existing culverts that are located under Patin Dyke Road and the railroad crossing. These culverts effectively restrict discharge and the railroad tracks are high enough in elevation to

prevent storm events overtopping them. Therefore, the most effective alternative is creating supplementary in-line storage by terracing the channel near the culverts. Additionally, the terraces are suitable locations to plant vegetation that will aid the removal of nitrogen and phosphorous.

The proposed boulder weirs are approximately half of the existing channels' height with a top width of 10-feet and side slopes at 2:1 (Figure 22). The proposed baffles block approximately half of the channel, causing stormwater runoff to flow around the obstructions. The baffles are approximately half of the channels' height and width with a top width of 10-feet and side slopes at 2:1 (Figure 23). Vegetation should be planted on the upstream and downstream sides of both the weirs and baffles and a riparian buffer should extend to a maximum of 100 feet from the banks. The proposed channel terracing begins at the existing channel centerline and extends at that elevation in both directions for 10-feet, steps up 4-feet and extends 20-feet, steps up 4-feet and extends 20-feet, and steps up once more to tie into the existing channel banks (Figure 24).

The following alternatives underwent a modeled and conceptual evaluation to determine feasibility and

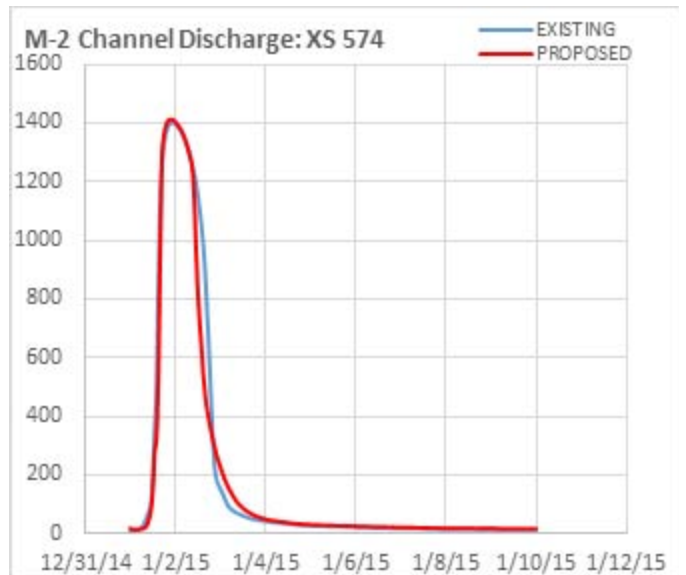
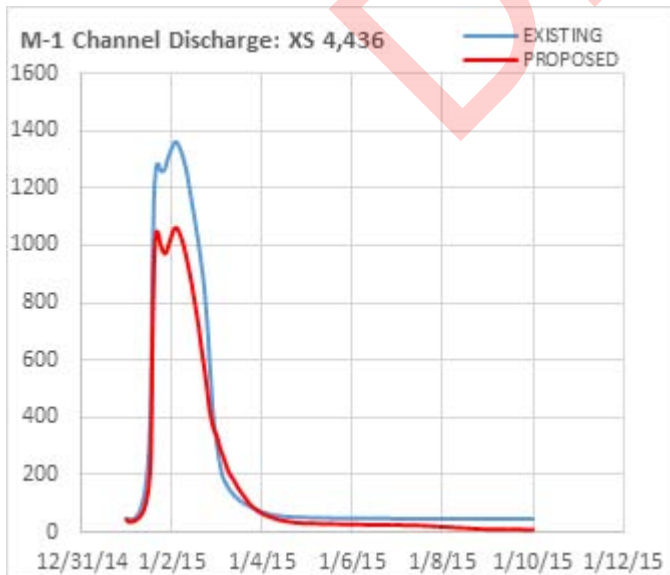
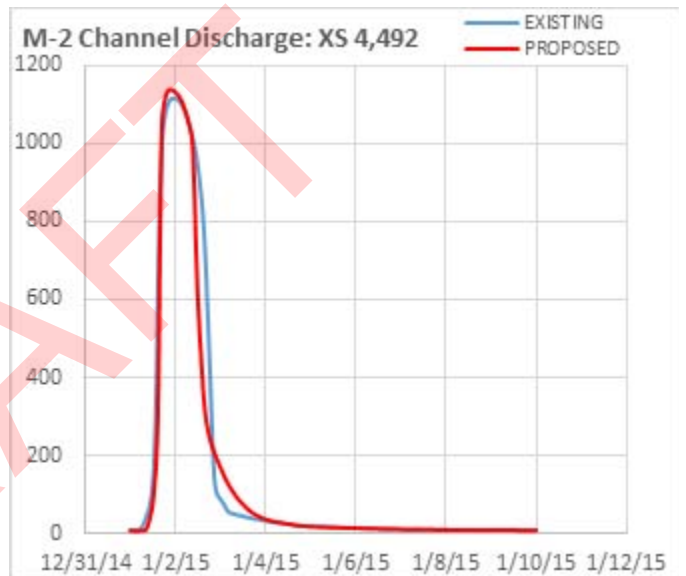
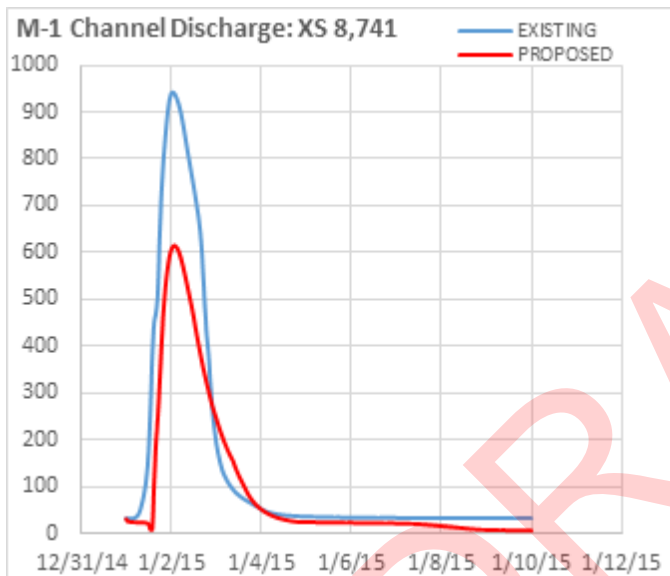
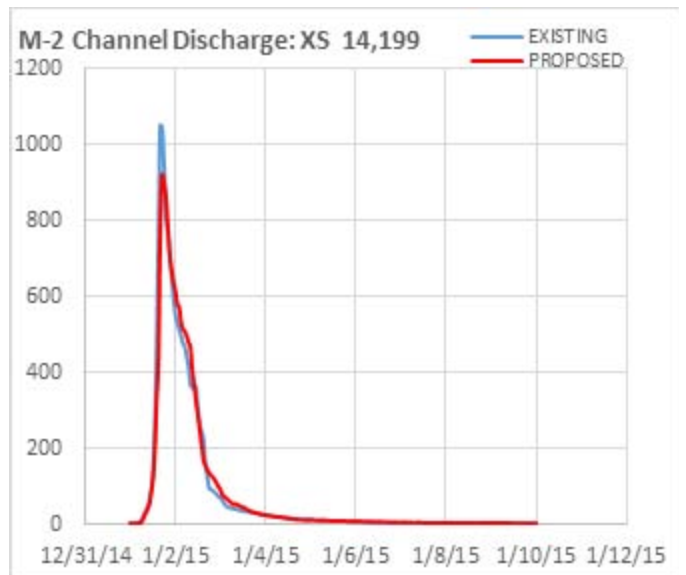
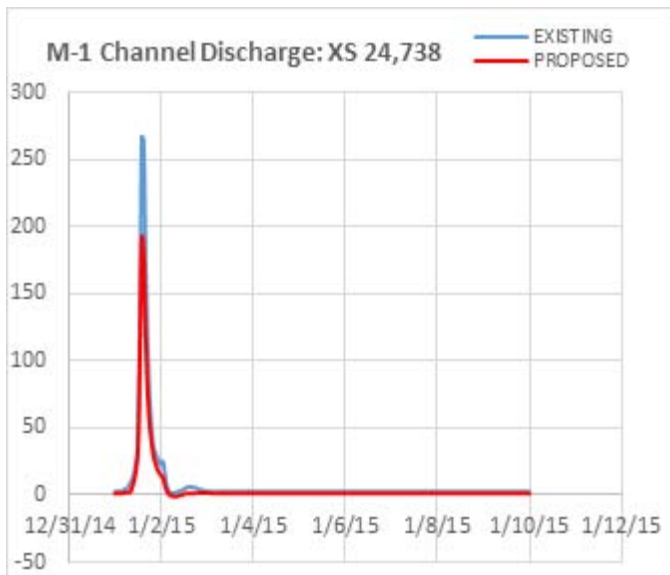

Figure 21 - Discharge Plots

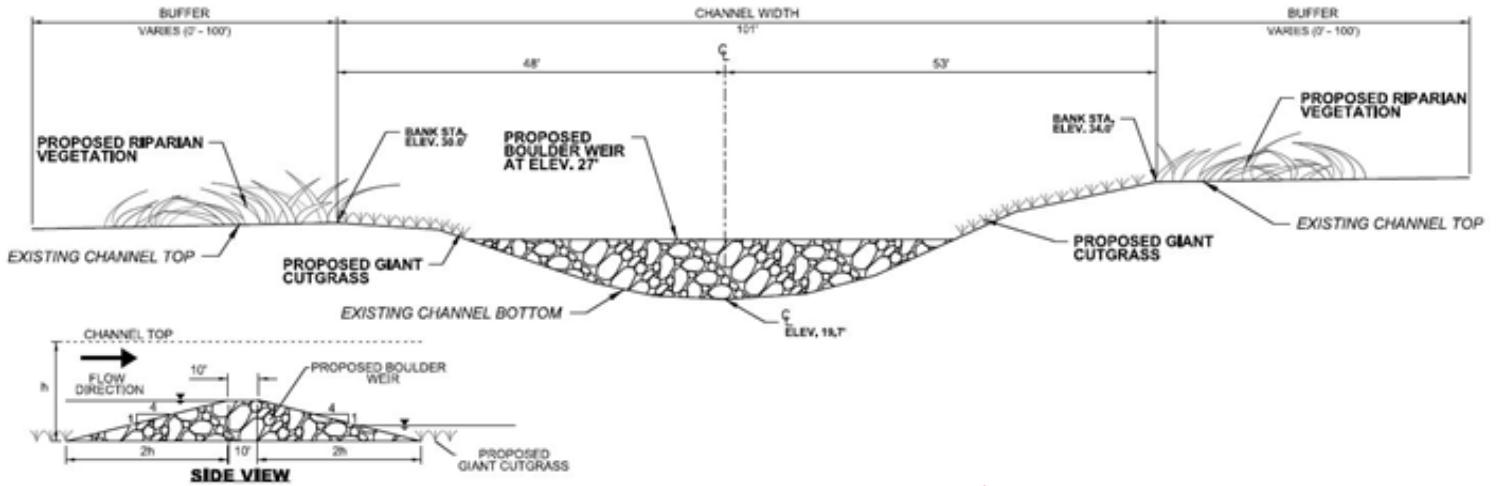

Figure 22 - Typical Weir Cross-Section

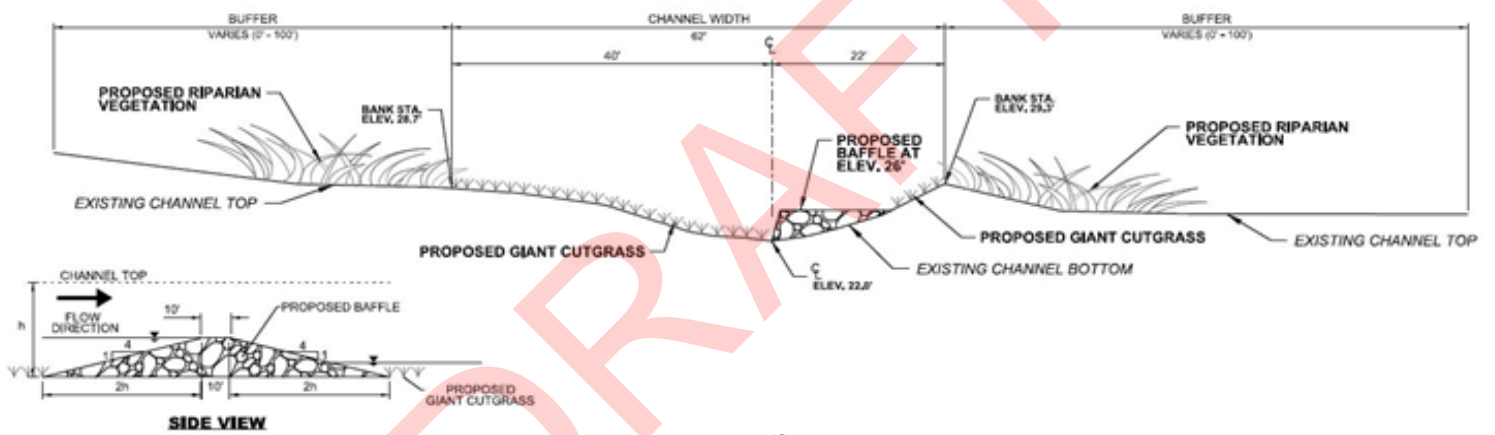

Figure 23 - Typical Baffle Cross-Section

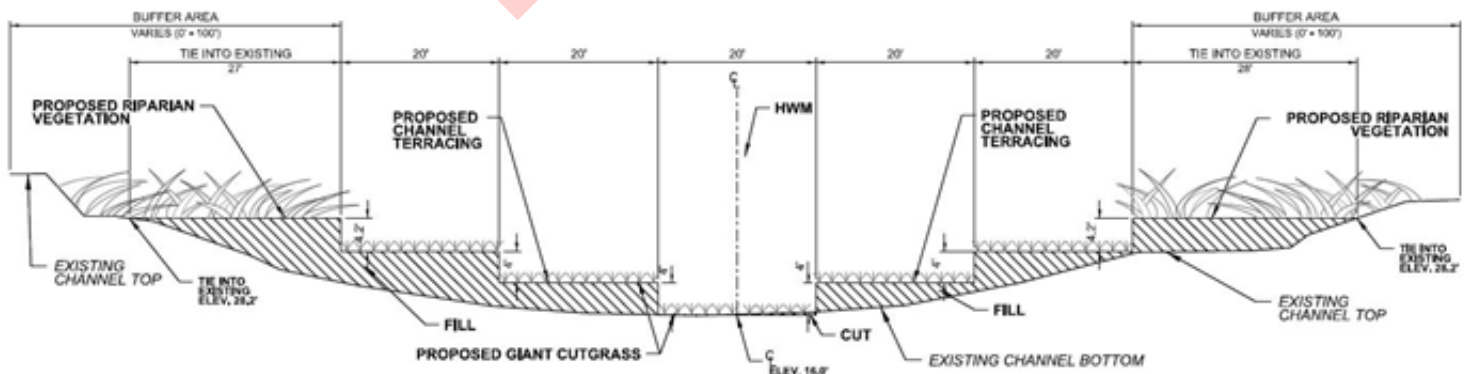

Figure 24 - Typical Terracing Cross-Section

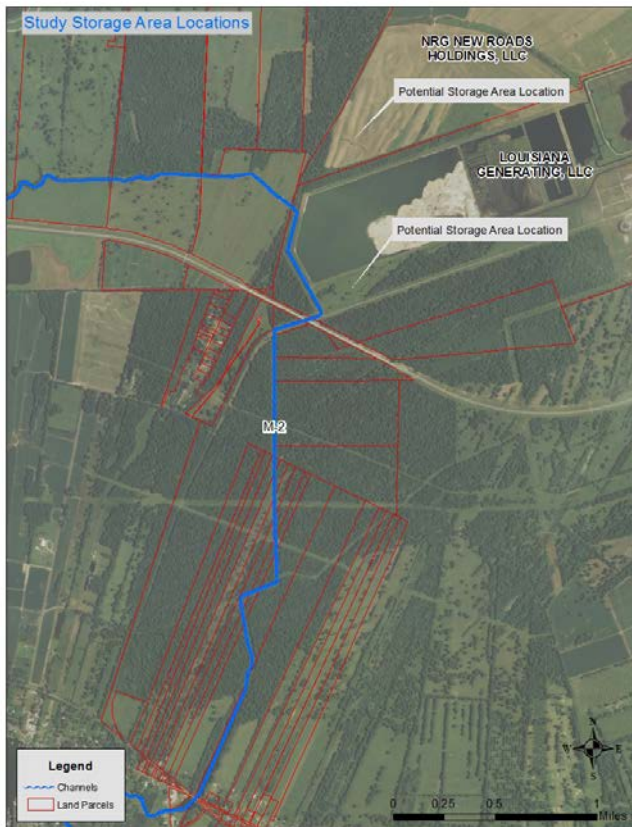

Figure 25 - Storage Area Locations

effectiveness: weirs only, weirs and storage area, terracing at the northern end of the M-2 Channel, terracing, weirs, and baffles.

Storage area runs examined converting land currently owned by NRG Energy (Figure 25) to a small 10-acre retention area and also a much larger 40-acre retention area. This alternative was not studied further because it provided a similar reduction in discharge as the preferred alternative. There was also concern in building these ponds due to the proximity of the existing ash pond. This alternative was not recommended due to the high cost of construction, minimal effectiveness, and landowner concerns.

Terracing at the locations owned by NRG at the northern part of the M-2 was also evaluated. These runs showed minimal discharge reduction due to how far upstream it's located along the M-2.

## RECOMMENDATIONS

### MAINTENANCE

Channel and riparian inspection and maintenance should be performed annually at a minimum. The channels and weirs should be inspected for damage and repairs made as necessary. Over time, sediment will deposit into the channel requiring removal to maintain efficiency of the weir system. Maintenance of the riparian buffer will include periodic removal and replacement of dead trees and shrubs, as well as inspection for damage from pests, wildlife, and vehicular or pedestrian traffic.

Some of the grasses, trees or shrubs chosen to supplement the existing vegetation may be planted for timber or other resources. Harvesting of grasses, trees, nuts, or fruits are permitted as long as these activities do not compromise the survival of the species or adversely affect the purpose of the riparian buffer zone. These activities should be outlined in a riparian buffer conservation plan (USDA NRCS, 2007).

## CONCLUSION

The False River Nitrogen Mitigation study utilized the findings from the 2013 False River Watershed report to implement nitrogen reduction measures within the entire watershed of False River. Water level and turbidity data was collected over a three month period and water sampling is an ongoing effort that is to occur over a four year period. The collected data along with the topographic and bathymetric survey, land use, soil, and rainfall data were used to develop hydrologic and hydraulic models. These models replicated existing conditions and evaluated several alternatives. The weir, baffle, and terracing alternative was recommended due to its reduction in discharge, constructability, and costs. This alternative showed a peak discharge reduction along the M-1 Channel of 30 percent during a 2-year, 24 hour storm event.

## BIBLIOGRAPHY

- BBC. (2013). Standard Grade Bitesize Geography- Processes Forming River Landscapes: Revision, Page 2. [http://www.bbc.co.uk/bitesize/standard/geography/rivers/river\\_forming/revision/2/](http://www.bbc.co.uk/bitesize/standard/geography/rivers/river_forming/revision/2/)
- Cooper, C. (1989). An Environmental Assessment of Moon Lake, Mississippi and its Watershed. Oxford, MS: United States Department of Agriculture. National Sedimentation Laboratory.
- Cooper, C., Smith Jr., S., & Moore, M. (2003). Surface Water, Ground Water and Sediment Quality in Three Oxbow Lake Watersheds in the Mississippi Delta Agricultural Region: Pesticides. *International Journal of Ecology and Environmental Sciences*, 29, 171-184.
- Dabney, S. et al. (1993). Vegetative barriers for runoff and sediment control. In: J. Mitchell, ed. *Integrated Resources Management and Landscape Modification for Environmental Protection*. St. Joseph, Michigan: ASAE, pp. 60-70.
- Das, B. M. (2006). *Principles of Geotechnical Engineering*. 6th ed. Toronto: Nelson.
- Ensminger, P. (1999). Bathymetric survey and physical and chemical-related properties of False River, Louisiana, June and July 1998: U.S. Geological Survey Water-Resources. Baton Rouge, LA: Louisiana Department of Transportation and Development - U.S. Geological Survey Water Resources Cooperative Program.
- FTN Associates. (1991). Final Report for Moon Lake – Phase I Diagnostic/Feasibility Study. Prepared for the MDEQ, Mississippi Office of Pollution: FTN Associates, Ltd.
- Fifield, J. S. (2001). *Designing for Effective Sediment and Erosion Control on Construction Sites*. 2nd ed. Santa Barbara, CA: Forester Press.
- Florida Department of Environmental Protection Nonpoint Source Management Section. (2008). *Florida Stormwater Erosion and Sedimentation Control Inspector's Manual*, Tallahassee, Florida: Florida Department of Environmental Protection.
- Garcia, M. H. (2008). *Sedimentation Engineering: Processes, Measurements, Modeling and Practice (ASCE Manuals and Reports on Engineering Practice No. 110)*. Reston, VA: American Society of Civil Engineers.
- GEC Environmental Resources. (2012). *Feasibility Report and Environmental Assessment - False River Aquatic Ecosystem Restoration, Point Coupee Parish, Louisiana (Interim Draft Vol. I-III)*. Baton Rouge, LA: GEC Environmental Resources.
- Haith, D., & Shoemaker, L. (1987). Generalized Watershed Loading Functions for Streamflow Nutrients. *Water Resources Bulletin*, 23(3), 471-478.
- Knight, S., King, M., Cooper, C. (2015). Suspended sediment impact on chlorophyll a, nitrogen and phosphorus relationships in Moon Lake, MS, USA. *The International Journal of Earth & Environmental Sciences*, 1(1).1-9.
- LDEQ. (2003). *Report on Water Quality Conditions on False River Lake*. Baton Rouge, LA: Louisiana Department of Environmental Quality.

- LDNR. (2008). BMPs for Coastal Louisiana Nonpoint Source Pollution: Urban Storm Water Runoff. <http://dnr.louisiana.gov/assets/docs/coastal/interagencyaff/nonpoint/BMP-Publication-UrbanRHB-Final.pdf>
- LDNR, False River Watershed Council, and C.H. Fenstermaker & Associates, L.L.C. (2013). False River Watershed Study: Discharge Bayou and the Chenal Drainage Network Assessment.
- LDNR and LDWF. (2012). False River Watershed Interim Report on HCR 168 of 2011. Regular Legislative Session. Baton Rouge, LA: Louisiana Department of Natural Resources and Louisiana Department of Wildlife and Fisheries.
- Lee, K., Isenhardt, T. & Schultz, R. (2003). Sediment and nutrient removal in an established multi-species riparian buffer. *Journal of Soil and Water Conservation*, 58(1), pp. 1-8.
- Lee, K., Isenhardt, T., Schultz, R. & Mickelson, S. (2000). Multispecies riparian buffers trap sediment and nutrients during rainfall simulations. *Journal of Environmental Quality*, Volume 29, pp. 1200-1205.
- Leonard, R. (1988). Herbicides in surface waters. In R. Grover (Ed.), *Environmental Chemistry of Herbicides* (pp. 45-87). Boca Raton, FL: CRC Publishing.
- Lind, Owen T., 1979, *Handbook of common methods in Limnology*, 2nd edition: C.V Mosby Co. St. Louis, MO.
- Lowrence, R., McIntyre, S. & Lance, C. (1988). Erosion and deposition in a field/forest system estimated using cesium-137 activity. *Journal of Soil and Water Conservation*, 43(2), pp. 195-199.
- Montana Department of Transportation. (2010). *Permanent Erosion and Sediment Control Design Guidelines (PESC Manual)*, Helena: Montana Department of Transportation.
- ODEQ. (2010). *Turbidity Technical Review*. Portland, OR: Oregon Department of Environmental Quality.
- Peterjohn, W. & Correll, D. (1984). Nutrient dynamics in an agricultural watershed: Observations on the role of a riparian forest. *Ecology*, Volume 65, pp. 1466 - 1475.
- Phillips, S. (2005). *The Impact of Sediment on the Chesapeake Bay and its Watershed*. <http://chesapeake.usgs.gov/SedimentBay605.pdf>
- Reid, George K. and Wood, Richard D., 1976, *Ecology of Inland Waters and Estuaries*, 2nd ed.: Van Nostrand Company, New York, NY, 485 pp.
- Saucier, R. T. (1994). *Geomorphology and Quaternary Geologic History of the Lower Mississippi Valley*. Vicksburg, Mississippi: U.S. Army Engineer Waterways Experiment Station.
- Storm Water Solutions. (2013). *Canal Cleanup*. <http://www.estormwater.com/canal-cleanup>
- Swackhamer, D.L., Paerl, H.W., Eisenreich, S.J., Hurley, H., Hornbuckle, K.C., McLachlan, M., Mount, D., Muir, D., and Schindler, D. (2004). Impacts of Atmospheric Pollutants to Aquatic Ecosystems: *Issues in Ecology*, Volume 12, p24.



- Tetra Tech. (2003). Total Maximum Daily Load for Sediment/Siltation - Moon Lake - Coahoma and Tunica Counties, Mississippi [Final report - September 2003]. Fairfax, VA: Tetra Tech, Inc.
- United States Army Corps of Engineers. (1989). Sedimentation Investigations of Rivers and Reservoirs. EM 1110-2-4000. Washington, DC: USACE (United States Army Corps of Engineers).
- USDA NRCS. (1986). Urban Hydrology for Small Watersheds, TR-55. Washington DC: United States Department of Agriculture.
- USDA NRCS. (2007). Hydrologic Soil Group, National Engineering Handbook (Part 630). Washington DC: United State Department of Agriculture.
- USDA NRCS. (2010). Natural Resources Conservation Service Conservation Practice Standard: Riparian Forest Buffer (Acre) Code 391. <ftp://ftp-fc.sc.egov.usda.gov/NHQ/practice-standards/standards/391.pdf>
- US EPA, 2009, National Lakes Assessment: A Collaborative Survey of the Nation's Lakes: EPA 841-R-09-001.
- US EPA. (2009). Summary of State Construction and Development Requirements - Appendix A-E. [http://water.epa.gov/scitech/wastetech/guide/construction/upload/2009\\_12\\_8\\_guide\\_construction\\_files\\_appendix\\_a.pdf](http://water.epa.gov/scitech/wastetech/guide/construction/upload/2009_12_8_guide_construction_files_appendix_a.pdf)
- US EPA. (2010). 2010 Waterbody Report for False River. [http://ofmpub.epa.gov/tmdl\\_waters10/attains\\_waterbody.control?p\\_au\\_id=LA120108\\_00&p\\_cycle=2010&p\\_state=LA&p\\_report\\_type=](http://ofmpub.epa.gov/tmdl_waters10/attains_waterbody.control?p_au_id=LA120108_00&p_cycle=2010&p_state=LA&p_report_type=)
- Vought, L.-M., Dahl, J., Pederson, C. & Lacoursière, J. (1994). Nutrient retention in riparian ecotones. *Ambio*, 23(6), pp. 342-348.
- Wilson, L. (1967). Sediment removal from flood water by grass filtration. *Transactions of the ASAE*, Volume 10, pp. 35-37.



## FALSE RIVER WATERSHED STUDY

Prepared for:  
Professional Engineering Consultants Corporation

Prepared by:  
C.H. Fenstermaker & Associates, L.L.C.  
April 12, 2016

# FALSE RIVER WATERSHED STUDY

## APPENDICES



C.H. FENSTERMAKER & ASSOCIATES, L.L.C.

April 12, 2016

# APPENDIX A: PLATES



# APPENDIX B: TIME OF CONCENTRATION SHEETS

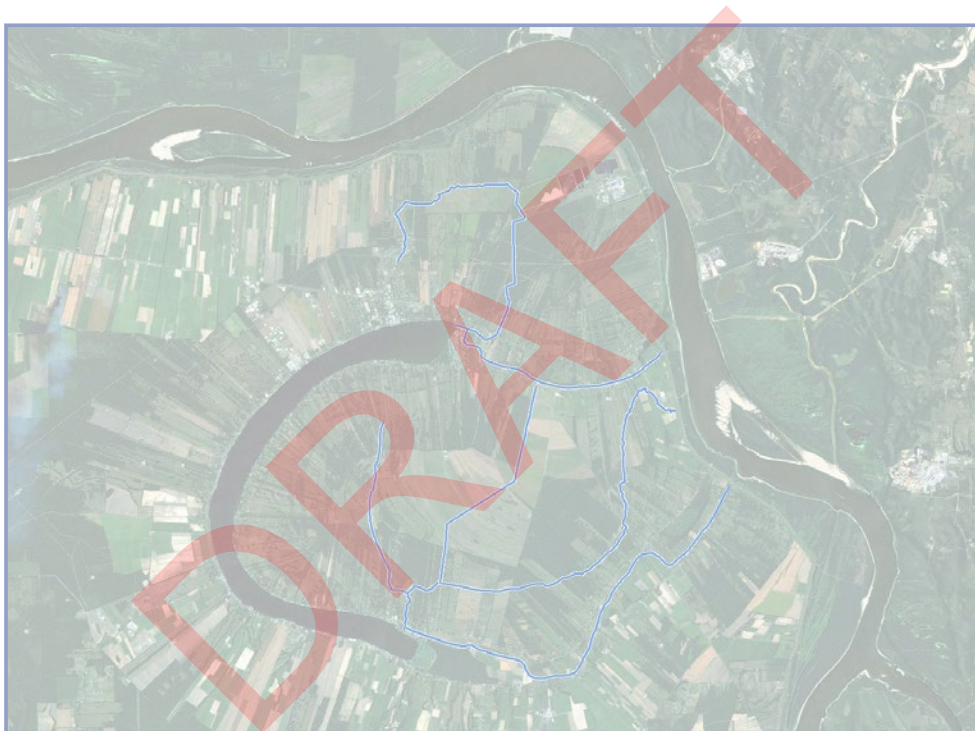

### Worksheet 3: Time of concentration (Tc) or travel time (Tt)

Project: False River By: JMS Date: 3/3/2013  
 Location: Pointe Coupee Parish Checked: \_\_\_\_\_ Date: \_\_\_\_\_

Check One: Present  Developed \_\_\_\_\_ **C-01**  
 Check One: T<sub>c</sub>  T<sub>t</sub> \_\_\_\_\_ **Existing**

Notes: Space for as many as two segments per flow type can be used for each worksheet.  
 Include a map, schematic, or description of flow segments.

#### Sheet Flow (Applicable to T<sub>c</sub> only)

	Segment ID	A		n/a	
1. Surface Description (Table 3-1) .....		Light Underbrush			
2. Manning's roughness coeff., n (Table 3-1) .....		0.400			
3. Flow length, L (total L ≤ 300 ft) .....	ft.	300.0			
4. Two-yr 24-hr rainfall, P <sub>2</sub> .....	in.	4.80			
5. Land Slope, s .....	ft. / ft.	0.02704			
6. T <sub>t</sub> = $\frac{0.007 (nL)^{0.8}}{(P_2^{0.5} s^{0.4})}$ .....	hr	0.624	+	0.000	= 0.624 hrs.
					= 37.42 minutes

#### Shallow concentrated flow

	Segment ID	B		n/a	
7. Surface description (paved or unpaved) .....		Unpaved			
8. Flow length, L .....	ft.	1,146.5			
9. Watercourse slope, s .....	ft. / ft.	0.01009			
10. Average velocity, V (figure 3-1) .....	ft. / s	1.621			
11. T <sub>t</sub> = $\frac{L}{3600 V}$ .....	hr	0.197	+	0.000	= 0.197 hrs.
					= 11.79 minutes

#### Channel flow

	Segment ID	C		n/a	
12. Cross sectional flow area, a .....	ft <sup>2</sup>	1,433.2			
13. Wetted perimeter, P <sub>w</sub> .....	ft.	145.1			
14. Hydraulic radius, r = $\frac{a}{P_w}$ .....	ft.	9.9			
15. Channel slope, s .....	ft. / ft.	0.00010			
16. Manning's roughness coeff., n .....		0.035			
17. V = $\frac{1.49 r^{2/3} s^{1/2}}{n}$ .....	ft. / s.	1.959			
18. Flow length, L .....	ft.	8,692.0			
19. T <sub>t</sub> = $\frac{L}{3600 V}$ .....	hr	1.232	+	0.000	= 1.232 hrs
					= 73.93 minutes
20. Watershed or subarea T <sub>c</sub> or T <sub>t</sub> (add T <sub>t</sub> in steps 6, 11, and 19) .....		2.052			hrs
		123.15			minutes
Value used for Analysis (Minimum T <sub>c</sub> 0.10 hours) .....		2.05			hrs

Reference: 210-VI-TR-55, Second Ed., June 1986

### Worksheet 3: Time of concentration (Tc) or travel time (Tt)

Project: False River By: JMS Date: 3/3/2013  
 Location: Pointe Coupee Parish Checked: \_\_\_\_\_ Date: \_\_\_\_\_

Check One: Present  Developed \_\_\_\_\_ **C-02**  
 Check One: T<sub>c</sub>  T<sub>t</sub> \_\_\_\_\_ **Existing**

Notes: Space for as many as two segments per flow type can be used for each worksheet.  
 Include a map, schematic, or description of flow segments.

#### Sheet Flow (Applicable to T<sub>c</sub> only)

	Segment ID	A	n/a	
1. Surface Description (Table 3-1) .....		Light Underbrush		
2. Manning's roughness coeff., n (Table 3-1) .....		0.400		
3. Flow length, L (total L ≤ 300 ft) .....	ft.	300.0		
4. Two-yr 24-hr rainfall, P <sub>2</sub> .....	in.	4.80		
5. Land Slope, s .....	ft. / ft.	0.00287		
6. T <sub>t</sub> = $\frac{0.007 (nL)^{0.8}}{(P_2^{0.5} s^{0.4})}$ .....	hr	1.530	+	0.000 = 1.530 hrs.
				= 91.80 minutes

#### Shallow concentrated flow

	Segment ID	B	n/a	
7. Surface description (paved or unpaved) .....		Unpaved		
8. Flow length, L .....	ft.	4,292.7		
9. Watercourse slope, s .....	ft. / ft.	0.00353		
10. Average velocity, V (figure 3-1) .....	ft. / s	0.958		
11. T <sub>t</sub> = $\frac{L}{3600 V}$ .....	hr	1.245	+	0.000 = 1.245 hrs.
				= 74.68 minutes

#### Channel flow

	Segment ID	C	n/a	
12. Cross sectional flow area, a .....	ft <sup>2</sup>	1,113.7		
13. Wetted perimeter, P <sub>w</sub> .....	ft.	134.4		
14. Hydraulic radius, r = $\frac{a}{P_w}$ .....	ft.	8.3		
15. Channel slope, s .....	ft. / ft.	0.00016		
16. Manning's roughness coeff., n .....		0.035		
17. V = $\frac{1.49 r^{2/3} s^{1/2}}{n}$ .....	ft. / s.	2.192		
18. Flow length, L .....	ft.	32,441.3		
19. T <sub>t</sub> = $\frac{L}{3600 V}$ .....	hr	4.112	+	0.000 = 4.112 hrs
				= 246.70 minutes
20. Watershed or subarea T <sub>c</sub> or T <sub>t</sub> (add T <sub>t</sub> in steps 6, 11, and 19) .....		6.886		hrs
		413.17		minutes
Value used for Analysis (Minimum T <sub>c</sub> 0.10 hours) .....		6.89		hrs

Reference: 210-VI-TR-55, Second Ed., June 1986

### Worksheet 3: Time of concentration (Tc) or travel time (Tt)

Project: False River By: JMS Date: 3/3/2013  
 Location: Pointe Coupee Parish Checked: \_\_\_\_\_ Date: \_\_\_\_\_

Check One: Present  Developed \_\_\_\_\_ E-01  
 Check One: T<sub>c</sub>  T<sub>t</sub> \_\_\_\_\_ Existing

Notes: Space for as many as two segments per flow type can be used for each worksheet.  
 Include a map, schematic, or description of flow segments.

#### Sheet Flow (Applicable to T<sub>c</sub> only)

	Segment ID	A		n/a	
1. Surface Description (Table 3-1) .....		Light Underbrush			
2. Manning's roughness coeff., n (Table 3-1) .....		0.400			
3. Flow length, L (total L ≤ 300 ft) .....	ft.	300.0			
4. Two-yr 24-hr rainfall, P <sub>2</sub> .....	in.	4.80			
5. Land Slope, s .....	ft. / ft.	0.00160			
6. T <sub>t</sub> = $\frac{0.007 (nL)^{0.8}}{(P_2^{0.5} s^{0.4})}$ .....	hr	1.933	+	0.000	= 1.933 hrs.
					= 115.96 minutes

#### Shallow concentrated flow

	Segment ID	B		n/a	
7. Surface description (paved or unpaved) .....		Unpaved			
8. Flow length, L .....	ft.	248.9			
9. Watercourse slope, s .....	ft. / ft.	0.00113			
10. Average velocity, V (figure 3-1) .....	ft. / s	0.543			
11. T <sub>t</sub> = $\frac{L}{3600 V}$ .....	hr	0.127	+	0.000	= 0.127 hrs.
					= 7.64 minutes

#### Channel flow

	Segment ID	C		n/a	
12. Cross sectional flow area, a .....	ft <sup>2</sup>	294.3			
13. Wetted perimeter, P <sub>w</sub> .....	ft.	58.2			
14. Hydraulic radius, r = $\frac{a}{P_w}$ .....	ft.	5.1			
15. Channel slope, s .....	ft. / ft.	0.00062			
16. Manning's roughness coeff., n .....		0.035			
17. V = $\frac{1.49 r^{2/3} s^{1/2}}{n}$ .....	ft. / s.	3.127			
18. Flow length, L .....	ft.	17,533.5			
19. T <sub>t</sub> = $\frac{L}{3600 V}$ .....	hr	1.558	+	0.000	= 1.558 hrs
					= 93.46 minutes
20. Watershed or subarea T <sub>c</sub> or T <sub>t</sub> (add T <sub>t</sub> in steps 6, 11, and 19) .....		3.618			hrs
		217.06			minutes
Value used for Analysis (Minimum T <sub>c</sub> 0.10 hours) .....		3.62			hrs

Reference: 210-VI-TR-55, Second Ed., June 1986



### Worksheet 3: Time of concentration (Tc) or travel time (Tt)

Project: False River By: JMS Date: 3/3/2013  
 Location: Pointe Coupee Parish Checked: \_\_\_\_\_ Date: \_\_\_\_\_

Check One: Present  Developed \_\_\_\_\_ E-02  
 Check One: T<sub>c</sub>  T<sub>t</sub> \_\_\_\_\_ Existing

Notes: Space for as many as two segments per flow type can be used for each worksheet.  
 Include a map, schematic, or description of flow segments.

#### Sheet Flow (Applicable to T<sub>c</sub> only)

	Segment ID	A	n/a	
1. Surface Description (Table 3-1) .....		Cultivated Soil		
2. Manning's roughness coeff., n (Table 3-1) .....		0.170		
3. Flow length, L (total L ≤ 300 ft) .....	ft.	300.0		
4. Two-yr 24-hr rainfall, P <sub>2</sub> .....	in.	4.80		
5. Land Slope, s .....	ft. / ft.	0.00209		
6. T <sub>t</sub> = $\frac{0.007 (nL)^{0.8}}{(P_2^{0.5} s^{0.4})}$ .....	hr	0.877	+ 0.000	= 0.877 hrs.
				= 52.60 minutes

#### Shallow concentrated flow

	Segment ID	B	n/a	
7. Surface description (paved or unpaved) .....		Unpaved		
8. Flow length, L .....	ft.	15,661.1		
9. Watercourse slope, s .....	ft. / ft.	0.00078		
10. Average velocity, V (figure 3-1) .....	ft. / s	0.451		
11. T <sub>t</sub> = $\frac{L}{3600 V}$ .....	hr	9.654	+ 0.000	= 9.654 hrs.
				= 579.25 minutes

#### Channel flow

	Segment ID	n/a	n/a	
12. Cross sectional flow area, a .....	ft <sup>2</sup>	0.0		
13. Wetted perimeter, P <sub>w</sub> .....	ft.	0.0		
14. Hydraulic radius, r = $\frac{a}{P_w}$ .....	ft.			
15. Channel slope, s .....	ft. / ft.	0.00010		
16. Manning's roughness coeff., n .....				
17. V = $\frac{1.49 r^{2/3} s^{1/2}}{n}$ .....	ft. / s.			
18. Flow length, L .....	ft.	0.0		
19. T <sub>t</sub> = $\frac{L}{3600 V}$ .....	hr	0.000	+ 0.000	= 0.000 hrs
				= 0.00 minutes
20. Watershed or subarea T <sub>c</sub> or T <sub>t</sub> (add T <sub>t</sub> in steps 6, 11, and 19) .....		10.531	hrs	
		631.85	minutes	
Value used for Analysis (Minimum T <sub>c</sub> 0.10 hours) .....		10.53	hrs	

Reference: 210-VI-TR-55, Second Ed., June 1986

### Worksheet 3: Time of concentration (Tc) or travel time (Tt)

Project: False River By: JMS Date: 3/3/2013  
 Location: Pointe Coupee Parish Checked: \_\_\_\_\_ Date: \_\_\_\_\_

Check One: Present  Developed \_\_\_\_\_ E-03  
 Check One: T<sub>c</sub>  T<sub>t</sub> \_\_\_\_\_ Existing

Notes: Space for as many as two segments per flow type can be used for each worksheet.  
 Include a map, schematic, or description of flow segments.

#### Sheet Flow (Applicable to T<sub>c</sub> only)

	Segment ID	A	n/a	
1. Surface Description (Table 3-1) .....		Cultivated Soil		
2. Manning's roughness coeff., n (Table 3-1) .....		0.170		
3. Flow length, L (total L ≤ 300 ft) .....	ft.	300.0		
4. Two-yr 24-hr rainfall, P <sub>2</sub> .....	in.	4.80		
5. Land Slope, s .....	ft. / ft.	0.00505		
6. T <sub>t</sub> = $\frac{0.007 (nL)^{0.8}}{(P_2^{0.5} s^{0.4})}$ .....	hr	0.616	+	0.000 = 0.616 hrs.
				= 36.93 minutes

#### Shallow concentrated flow

	Segment ID	B	n/a	
7. Surface description (paved or unpaved) .....		Unpaved		
8. Flow length, L .....	ft.	8,045.8		
9. Watercourse slope, s .....	ft. / ft.	0.00083		
10. Average velocity, V (figure 3-1) .....	ft. / s	0.465		
11. T <sub>t</sub> = $\frac{L}{3600 V}$ .....	hr	4.805	+	0.000 = 4.805 hrs.
				= 288.31 minutes

#### Channel flow

	Segment ID	C	n/a	
12. Cross sectional flow area, a .....	ft <sup>2</sup>	253.3		
13. Wetted perimeter, P <sub>w</sub> .....	ft.	54.4		
14. Hydraulic radius, r = $\frac{a}{P_w}$ .....	ft.	4.7		
15. Channel slope, s .....	ft. / ft.	0.00010		
16. Manning's roughness coeff., n .....		0.040		
17. V = $\frac{1.49 r^{2/3} s^{1/2}}{n}$ .....	ft. / s.	1.039		
18. Flow length, L .....	ft.	9,219.8		
19. T <sub>t</sub> = $\frac{L}{3600 V}$ .....	hr	2.464	+	0.000 = 2.464 hrs
				= 147.85 minutes
20. Watershed or subarea T <sub>c</sub> or T <sub>t</sub> (add T <sub>t</sub> in steps 6, 11, and 19) .....		7.885		hrs
		473.10		minutes
Value used for Analysis (Minimum T <sub>c</sub> 0.10 hours) .....		7.88		hrs

Reference: 210-VI-TR-55, Second Ed., June 1986

### Worksheet 3: Time of concentration (Tc) or travel time (Tt)

Project: False River By: JMS Date: 3/3/2013  
 Location: Pointe Coupee Parish Checked: \_\_\_\_\_ Date: \_\_\_\_\_

Check One: Present X Developed \_\_\_\_\_ E-04  
 Check One: T<sub>c</sub> X T<sub>t</sub> \_\_\_\_\_ Existing

Notes: Space for as many as two segments per flow type can be used for each worksheet.  
 Include a map, schematic, or description of flow segments.

#### Sheet Flow (Applicable to T<sub>c</sub> only)

	Segment ID	A	n/a	
1. Surface Description (Table 3-1) .....		Cultivated Soil		
2. Manning's roughness coeff., n (Table 3-1) .....		0.170		
3. Flow length, L (total L ≤ 300 ft) .....	ft.	300.0		
4. Two-yr 24-hr rainfall, P <sub>2</sub> .....	in.	4.80		
5. Land Slope, s .....	ft. / ft.	0.00049		
6. T <sub>t</sub> = $\frac{0.007 (nL)^{0.8}}{(P_2^{0.5} s^{0.4})}$ .....	hr	1.570	+	0.000
			=	1.570 hrs.
			=	94.20 minutes

#### Shallow concentrated flow

	Segment ID	B	n/a	
7. Surface description (paved or unpaved) .....		Unpaved		
8. Flow length, L .....	ft.	4,027.6		
9. Watercourse slope, s .....	ft. / ft.	0.00105		
10. Average velocity, V (figure 3-1) .....	ft. / s	0.522		
11. T <sub>t</sub> = $\frac{L}{3600 V}$ .....	hr	2.142	+	0.000
			=	2.142 hrs.
			=	128.52 minutes

#### Channel flow

	Segment ID	C	n/a	
12. Cross sectional flow area, a .....	ft <sup>2</sup>	253.3		
13. Wetted perimeter, P <sub>w</sub> .....	ft.	54.4		
14. Hydraulic radius, r = $\frac{a}{P_w}$ .....	ft.	4.7		
15. Channel slope, s .....	ft. / ft.	0.00372		
16. Manning's roughness coeff., n .....		0.040		
17. V = $\frac{1.49 r^{2/3} s^{1/2}}{n}$ .....	ft. / s.	6.336		
18. Flow length, L .....	ft.	829.3		
19. T <sub>t</sub> = $\frac{L}{3600 V}$ .....	hr	0.036	+	0.000
			=	0.036 hrs
			=	2.18 minutes
20. Watershed or subarea T <sub>c</sub> or T <sub>t</sub> (add T <sub>t</sub> in steps 6, 11, and 19) .....		3.748		hrs
		224.90		minutes
Value used for Analysis (Minimum T <sub>c</sub> 0.10 hours) .....		3.75		hrs

Reference: 210-VI-TR-55, Second Ed., June 1986

### Worksheet 3: Time of concentration (Tc) or travel time (Tt)

Project: False River By: JMS Date: 3/3/2013  
 Location: Pointe Coupee Parish Checked: \_\_\_\_\_ Date: \_\_\_\_\_

Check One: Present X Developed \_\_\_\_\_ FR-01  
 Check One: T<sub>c</sub> X T<sub>t</sub> \_\_\_\_\_ Existing

Notes: Space for as many as two segments per flow type can be used for each worksheet.  
 Include a map, schematic, or description of flow segments.

#### Sheet Flow (Applicable to T<sub>c</sub> only)

	Segment ID	A	n/a	
1. Surface Description (Table 3-1) .....		Smooth Surface		
2. Manning's roughness coeff., n (Table 3-1) .....		0.011		
3. Flow length, L (total L ≤ 300 ft) .....	ft.	0.0		
4. Two-yr 24-hr rainfall, P <sub>2</sub> .....	in.	4.80		
5. Land Slope, s .....	ft. / ft.	0.00010		
6. T <sub>t</sub> = $\frac{0.007 (nL)^{0.8}}{(P_2^{0.5} s^{0.4})}$ .....	hr	0.000	+	0.000 = 0.000 hrs.
				= 0.00 minutes

#### Shallow concentrated flow

	Segment ID	B	n/a	
7. Surface description (paved or unpaved) .....		Unpaved		
8. Flow length, L .....	ft.	0.0		
9. Watercourse slope, s .....	ft. / ft.	0.00010		
10. Average velocity, V (figure 3-1) .....	ft. / s	0.161		
11. T <sub>t</sub> = $\frac{L}{3600 V}$ .....	hr	0.000	+	0.000 = 0.000 hrs.
				= 0.00 minutes

#### Channel flow

	Segment ID	n/a	n/a	
12. Cross sectional flow area, a .....	ft <sup>2</sup>	0.0		
13. Wetted perimeter, P <sub>w</sub> .....	ft.	0.0		
14. Hydraulic radius, $r = \frac{a}{P_w}$ .....	ft.			
15. Channel slope, s .....	ft. / ft.	0.00010		
16. Manning's roughness coeff., n .....		0.040		
17. $V = \frac{1.49 r^{2/3} s^{1/2}}{n}$ .....	ft. / s.			
18. Flow length, L .....	ft.	0.0		
19. T <sub>t</sub> = $\frac{L}{3600 V}$ .....	hr	0.000	+	0.000 = 0.000 hrs
				= 0.00 minutes
20. Watershed or subarea T <sub>c</sub> or T <sub>t</sub> (add T <sub>t</sub> in steps 6, 11, and 19) .....		0.000		hrs
		0.00		minutes
Value used for Analysis (Minimum T <sub>c</sub> 0.10 hours) .....		0.10		hrs

Reference: 210-VI-TR-55, Second Ed., June 1986

### Worksheet 3: Time of concentration (Tc) or travel time (Tt)

Project: False River By: JMS Date: 3/3/2013  
 Location: Pointe Coupee Parish Checked: \_\_\_\_\_ Date: \_\_\_\_\_  
 Check One: Present X Developed \_\_\_\_\_ FR-02  
 Check One: T<sub>c</sub> X T<sub>t</sub> \_\_\_\_\_ Existing

Notes: Space for as many as two segments per flow type can be used for each worksheet. Include a map, schematic, or description of flow segments.

#### Sheet Flow (Applicable to T<sub>c</sub> only)

	Segment ID	A	n/a	
1. Surface Description (Table 3-1) .....		Grass		
2. Manning's roughness coeff., n (Table 3-1) .....		0.150		
3. Flow length, L (total L ≤ 300 ft) .....	ft.	300.0		
4. Two-yr 24-hr rainfall, P <sub>2</sub> .....	in.	4.80		
5. Land Slope, s .....	ft. / ft.	0.00284		
6. T <sub>t</sub> = $\frac{0.007 (nL)^{0.8}}{(P_2^{0.5} s^{0.4})}$ .....	hr	0.701	+	0.000 = 0.701 hrs.
				= 42.07 minutes

#### Shallow concentrated flow

	Segment ID	B	n/a	
7. Surface description (paved or unpaved) .....		Unpaved		
8. Flow length, L .....	ft.	16,626.8		
9. Watercourse slope, s .....	ft. / ft.	0.00056		
10. Average velocity, V (figure 3-1) .....	ft. / s	0.383		
11. T <sub>t</sub> = $\frac{L}{3600 V}$ .....	hr	12.053	+	0.000 = 12.053 hrs.
				= 723.21 minutes

#### Channel flow

	Segment ID	n/a	n/a	
12. Cross sectional flow area, a .....	ft <sup>2</sup>	0.0		
13. Wetted perimeter, P <sub>w</sub> .....	ft.	0.0		
14. Hydraulic radius, r = $\frac{a}{P_w}$ .....	ft.			
15. Channel slope, s .....	ft. / ft.	0.00010		
16. Manning's roughness coeff., n .....		0.040		
17. V = $\frac{1.49 r^{2/3} s^{1/2}}{n}$ .....	ft. / s.			
18. Flow length, L .....	ft.	0.0		
19. T <sub>t</sub> = $\frac{L}{3600 V}$ .....	hr	0.000	+	0.000 = 0.000 hrs
				= 0.00 minutes
20. Watershed or subarea T <sub>c</sub> or T <sub>t</sub> (add T <sub>t</sub> in steps 6, 11, and 19) .....				12.755 hrs
				765.28 minutes
Value used for Analysis (Minimum T <sub>c</sub> 0.10 hours) .....				12.75 hrs

Reference: 210-VI-TR-55, Second Ed., June 1986

### Worksheet 3: Time of concentration (Tc) or travel time (Tt)

Project: False River By: JMS Date: 3/3/2013  
 Location: Pointe Coupee Parish Checked: \_\_\_\_\_ Date: \_\_\_\_\_

Check One: Present  Developed \_\_\_\_\_ FR-03  
 Check One: T<sub>c</sub>  T<sub>t</sub> \_\_\_\_\_ Existing

Notes: Space for as many as two segments per flow type can be used for each worksheet.  
 Include a map, schematic, or description of flow segments.

#### Sheet Flow (Applicable to T<sub>c</sub> only)

	Segment ID	A	n/a	
1. Surface Description (Table 3-1) .....		Grass		
2. Manning's roughness coeff., n (Table 3-1) .....		0.150		
3. Flow length, L (total L ≤ 300 ft) .....	ft.	300.0		
4. Two-yr 24-hr rainfall, P <sub>2</sub> .....	in.	4.80		
5. Land Slope, s .....	ft. / ft.	0.00243		
6. T <sub>t</sub> = $\frac{0.007 (nL)^{0.8}}{(P_2^{0.5} s^{0.4})}$ .....	hr	0.746	+	0.000 = 0.746 hrs.
				= 44.74 minutes

#### Shallow concentrated flow

	Segment ID	B	n/a	
7. Surface description (paved or unpaved) .....		Unpaved		
8. Flow length, L .....	ft.	5,907.8		
9. Watercourse slope, s .....	ft. / ft.	0.00181		
10. Average velocity, V (figure 3-1) .....	ft. / s	0.687		
11. T <sub>t</sub> = $\frac{L}{3600 V}$ .....	hr	2.389	+	0.000 = 2.389 hrs.
				= 143.33 minutes

#### Channel flow

	Segment ID	n/a	n/a	
12. Cross sectional flow area, a .....	ft <sup>2</sup>	0.0		
13. Wetted perimeter, P <sub>w</sub> .....	ft.	0.0		
14. Hydraulic radius, r = $\frac{a}{P_w}$ .....	ft.			
15. Channel slope, s .....	ft. / ft.	0.00010		
16. Manning's roughness coeff., n .....		0.040		
17. V = $\frac{1.49 r^{2/3} s^{1/2}}{n}$ .....	ft. / s.			
18. Flow length, L .....	ft.	0.0		
19. T <sub>t</sub> = $\frac{L}{3600 V}$ .....	hr	0.000	+	0.000 = 0.000 hrs
				= 0.00 minutes
20. Watershed or subarea T <sub>c</sub> or T <sub>t</sub> (add T <sub>t</sub> in steps 6, 11, and 19) .....				3.134 hrs
				188.06 minutes
Value used for Analysis (Minimum T <sub>c</sub> 0.10 hours) .....				<b>3.13 hrs</b>

Reference: 210-VI-TR-55, Second Ed., June 1986

### Worksheet 3: Time of concentration (Tc) or travel time (Tt)

Project: False River By: JMS Date: 3/3/2013  
 Location: Pointe Coupee Parish Checked: \_\_\_\_\_ Date: \_\_\_\_\_

Check One: Present  Developed \_\_\_\_\_ M1-01  
 Check One: T<sub>c</sub>  T<sub>t</sub> \_\_\_\_\_ Existing

Notes: Space for as many as two segments per flow type can be used for each worksheet.  
 Include a map, schematic, or description of flow segments.

#### Sheet Flow (Applicable to T<sub>c</sub> only)

	Segment ID	A	n/a	
1. Surface Description (Table 3-1) .....		Grass		
2. Manning's roughness coeff., n (Table 3-1) .....		0.150		
3. Flow length, L (total L ≤ 300 ft) .....	ft.	300.0		
4. Two-yr 24-hr rainfall, P <sub>2</sub> .....	in.	4.80		
5. Land Slope, s .....	ft. / ft.	0.00300		
6. T <sub>t</sub> = $\frac{0.007 (nL)^{0.8}}{(P_2^{0.5} s^{0.4})}$ .....	hr	0.686	+	0.000
			=	0.686 hrs.
			=	41.15 minutes

#### Shallow concentrated flow

	Segment ID	B	n/a	
7. Surface description (paved or unpaved) .....		Unpaved		
8. Flow length, L .....	ft.	4,641.2		
9. Watercourse slope, s .....	ft. / ft.	0.00279		
10. Average velocity, V (figure 3-1) .....	ft. / s	0.852		
11. T <sub>t</sub> = $\frac{L}{3600 V}$ .....	hr	1.513	+	0.000
			=	1.513 hrs.
			=	90.78 minutes

#### Channel flow

	Segment ID	C	n/a	
12. Cross sectional flow area, a .....	ft <sup>2</sup>	673.8		
13. Wetted perimeter, P <sub>w</sub> .....	ft.	95.9		
14. Hydraulic radius, r = $\frac{a}{P_w}$ .....	ft.	7.0		
15. Channel slope, s .....	ft. / ft.	0.00046		
16. Manning's roughness coeff., n .....		0.035		
17. V = $\frac{1.49 r^{2/3} s^{1/2}}{n}$ .....	ft. / s.	3.335		
18. Flow length, L .....	ft.	2,458.6		
19. T <sub>t</sub> = $\frac{L}{3600 V}$ .....	hr	0.205	+	0.000
			=	0.205 hrs
			=	12.29 minutes
20. Watershed or subarea T <sub>c</sub> or T <sub>t</sub> (add T <sub>t</sub> in steps 6, 11, and 19) .....		2.404		hrs
		144.22		minutes
Value used for Analysis (Minimum T <sub>c</sub> 0.10 hours) .....		2.40		hrs

Reference: 210-VI-TR-55, Second Ed., June 1986

### Worksheet 3: Time of concentration (Tc) or travel time (Tt)

Project: False River By: JMS Date: 3/3/2013  
 Location: Pointe Coupee Parish Checked: \_\_\_\_\_ Date: \_\_\_\_\_

Check One: Present X Developed \_\_\_\_\_ M1-02  
 Check One: T<sub>c</sub> X T<sub>t</sub> \_\_\_\_\_ Existing

Notes: Space for as many as two segments per flow type can be used for each worksheet.  
 Include a map, schematic, or description of flow segments.

#### Sheet Flow (Applicable to T<sub>c</sub> only)

	Segment ID	A		n/a	
1. Surface Description (Table 3-1) .....		Light Underbrush			
2. Manning's roughness coeff., n (Table 3-1) .....		0.400			
3. Flow length, L (total L ≤ 300 ft) .....	ft.	300.0			
4. Two-yr 24-hr rainfall, P <sub>2</sub> .....	in.	4.80			
5. Land Slope, s .....	ft. / ft.	0.02128			
6. T <sub>t</sub> = $\frac{0.007 (nL)^{0.8}}{(P_2^{0.5} s^{0.4})}$ .....	hr	0.686	+	0.000	= 0.686 hrs.
					= 41.19 minutes

#### Shallow concentrated flow

	Segment ID	B		n/a	
7. Surface description (paved or unpaved) .....		Unpaved			
8. Flow length, L .....	ft.	23,774.3			
9. Watercourse slope, s .....	ft. / ft.	0.00022			
10. Average velocity, V (figure 3-1) .....	ft. / s	0.238			
11. T <sub>t</sub> = $\frac{L}{3600 V}$ .....	hr	27.786	+	0.000	= 27.786 hrs.
					= 1667.13 minutes

#### Channel flow

	Segment ID	n/a		n/a	
12. Cross sectional flow area, a .....	ft <sup>2</sup>	0.0			
13. Wetted perimeter, P <sub>w</sub> .....	ft.	0.0			
14. Hydraulic radius, r = $\frac{a}{P_w}$ .....	ft.				
15. Channel slope, s .....	ft. / ft.	0.00010			
16. Manning's roughness coeff., n .....					
17. V = $\frac{1.49 r^{2/3} s^{1/2}}{n}$ .....	ft. / s.				
18. Flow length, L .....	ft.	0.0			
19. T <sub>t</sub> = $\frac{L}{3600 V}$ .....	hr	0.000	+	0.000	= 0.000 hrs
					= 0.00 minutes
20. Watershed or subarea T <sub>c</sub> or T <sub>t</sub> (add T <sub>t</sub> in steps 6, 11, and 19) .....		28.472		hrs	
		1708.32		minutes	
Value used for Analysis (Minimum T <sub>c</sub> 0.10 hours) .....		28.47		hrs	

Reference: 210-VI-TR-55, Second Ed., June 1986



### Worksheet 3: Time of concentration (Tc) or travel time (Tt)

Project: False River By: JMS Date: 3/3/2013  
 Location: Pointe Coupee Parish Checked: \_\_\_\_\_ Date: \_\_\_\_\_

Check One: Present  Developed \_\_\_\_\_ M1-03  
 Check One: T<sub>c</sub>  T<sub>t</sub> \_\_\_\_\_ Existing

Notes: Space for as many as two segments per flow type can be used for each worksheet.  
 Include a map, schematic, or description of flow segments.

#### Sheet Flow (Applicable to T<sub>c</sub> only)

	Segment ID	A		n/a	
1. Surface Description (Table 3-1) .....		Light Underbrush			
2. Manning's roughness coeff., n (Table 3-1) .....		0.400			
3. Flow length, L (total L ≤ 300 ft) .....	ft.	300.0			
4. Two-yr 24-hr rainfall, P <sub>2</sub> .....	in.	4.80			
5. Land Slope, s .....	ft. / ft.	0.01222			
6. T <sub>t</sub> = $\frac{0.007 (nL)^{0.8}}{(P_2^{0.5} s^{0.4})}$ .....	hr	0.857	+	0.000	= 0.857 hrs.
					= 51.43 minutes

#### Shallow concentrated flow

	Segment ID	B		n/a	
7. Surface description (paved or unpaved) .....		Unpaved			
8. Flow length, L .....	ft.	20,728.1			
9. Watercourse slope, s .....	ft. / ft.	0.00013			
10. Average velocity, V (figure 3-1) .....	ft. / s	0.185			
11. T <sub>t</sub> = $\frac{L}{3600 V}$ .....	hr	31.061	+	0.000	= 31.061 hrs.
					= 1863.66 minutes

#### Channel flow

	Segment ID	n/a		n/a	
12. Cross sectional flow area, a .....	ft <sup>2</sup>	0.0			
13. Wetted perimeter, P <sub>w</sub> .....	ft.	0.0			
14. Hydraulic radius, r = $\frac{a}{P_w}$ .....	ft.				
15. Channel slope, s .....	ft. / ft.	0.00010			
16. Manning's roughness coeff., n .....					
17. V = $\frac{1.49 r^{2/3} s^{1/2}}{n}$ .....	ft. / s.				
18. Flow length, L .....	ft.	0.0			
19. T <sub>t</sub> = $\frac{L}{3600 V}$ .....	hr	0.000	+	0.000	= 0.000 hrs
					= 0.00 minutes
20. Watershed or subarea T <sub>c</sub> or T <sub>t</sub> (add T <sub>t</sub> in steps 6, 11, and 19) .....		31.918			hrs
		1915.08			minutes
Value used for Analysis (Minimum T <sub>c</sub> 0.10 hours) .....		31.92			hrs

Reference: 210-VI-TR-55, Second Ed., June 1986

### Worksheet 3: Time of concentration (Tc) or travel time (Tt)

Project: False River By: JMS Date: 3/3/2013  
 Location: Pointe Coupee Parish Checked: \_\_\_\_\_ Date: \_\_\_\_\_

Check One: Present  Developed \_\_\_\_\_ M1-04  
 Check One: T<sub>c</sub>  T<sub>t</sub> \_\_\_\_\_ Existing

Notes: Space for as many as two segments per flow type can be used for each worksheet.  
 Include a map, schematic, or description of flow segments.

#### Sheet Flow (Applicable to T<sub>c</sub> only)

	Segment ID	A	n/a	
1. Surface Description (Table 3-1) .....		Grass		
2. Manning's roughness coeff., n (Table 3-1) .....		0.150		
3. Flow length, L (total L ≤ 300 ft) .....	ft.	300.0		
4. Two-yr 24-hr rainfall, P <sub>2</sub> .....	in.	4.80		
5. Land Slope, s .....	ft. / ft.	0.00291		
6. T <sub>t</sub> = $\frac{0.007 (nL)^{0.8}}{(P_2^{0.5} s^{0.4})}$ .....	hr	0.694	+	0.000 = 0.694 hrs.
				= 41.65 minutes

#### Shallow concentrated flow

	Segment ID	B	n/a	
7. Surface description (paved or unpaved) .....		Unpaved		
8. Flow length, L .....	ft.	7,899.7		
9. Watercourse slope, s .....	ft. / ft.	0.00155		
10. Average velocity, V (figure 3-1) .....	ft. / s	0.635		
11. T <sub>t</sub> = $\frac{L}{3600 V}$ .....	hr	3.453	+	0.000 = 3.453 hrs.
				= 207.20 minutes

#### Channel flow

	Segment ID	C	n/a	
12. Cross sectional flow area, a .....	ft <sup>2</sup>	592.4		
13. Wetted perimeter, P <sub>w</sub> .....	ft.	85.3		
14. Hydraulic radius, $r = \frac{a}{P_w}$ .....	ft.	6.9		
15. Channel slope, s .....	ft. / ft.	0.00010		
16. Manning's roughness coeff., n .....		0.035		
17. V = $\frac{1.49 r^{2/3} s^{1/2}}{n}$ .....	ft. / s.	1.550		
18. Flow length, L .....	ft.	3,334.1		
19. T <sub>t</sub> = $\frac{L}{3600 V}$ .....	hr	0.598	+	0.000 = 0.598 hrs
				= 35.86 minutes
20. Watershed or subarea T <sub>c</sub> or T <sub>t</sub> (add T <sub>t</sub> in steps 6, 11, and 19) .....		4.745		hrs
		284.72		minutes
Value used for Analysis (Minimum T <sub>c</sub> 0.10 hours) .....		4.75		hrs

Reference: 210-VI-TR-55, Second Ed., June 1986

### Worksheet 3: Time of concentration (Tc) or travel time (Tt)

Project: False River By: JMS Date: 3/3/2013  
 Location: Pointe Coupee Parish Checked: \_\_\_\_\_ Date: \_\_\_\_\_

Check One: Present  Developed \_\_\_\_\_ M1-05  
 Check One: T<sub>c</sub>  T<sub>t</sub> \_\_\_\_\_ Existing

Notes: Space for as many as two segments per flow type can be used for each worksheet.  
 Include a map, schematic, or description of flow segments.

#### Sheet Flow (Applicable to T<sub>c</sub> only)

	Segment ID	A	n/a	
1. Surface Description (Table 3-1) .....		Grass		
2. Manning's roughness coeff., n (Table 3-1) .....		0.150		
3. Flow length, L (total L ≤ 300 ft) .....	ft.	300.0		
4. Two-yr 24-hr rainfall, P <sub>2</sub> .....	in.	4.80		
5. Land Slope, s .....	ft. / ft.	0.01687		
6. T <sub>t</sub> = $\frac{0.007 (nL)^{0.8}}{(P_2^{0.5} s^{0.4})}$ .....	hr	0.344	+	0.000 = 0.344 hrs.
				= 20.62 minutes

#### Shallow concentrated flow

	Segment ID	B	n/a	
7. Surface description (paved or unpaved) .....		Unpaved		
8. Flow length, L .....	ft.	18,936.3		
9. Watercourse slope, s .....	ft. / ft.	0.00030		
10. Average velocity, V (figure 3-1) .....	ft. / s	0.279		
11. T <sub>t</sub> = $\frac{L}{3600 V}$ .....	hr	18.885	+	0.000 = 18.885 hrs.
				= 1133.13 minutes

#### Channel flow

	Segment ID	n/a	n/a	
12. Cross sectional flow area, a .....	ft <sup>2</sup>	0.0		
13. Wetted perimeter, P <sub>w</sub> .....	ft.	0.0		
14. Hydraulic radius, r = $\frac{a}{P_w}$ .....	ft.			
15. Channel slope, s .....	ft. / ft.	0.00010		
16. Manning's roughness coeff., n .....				
17. V = $\frac{1.49 r^{2/3} s^{1/2}}{n}$ .....	ft. / s.			
18. Flow length, L .....	ft.	0.0		
19. T <sub>t</sub> = $\frac{L}{3600 V}$ .....	hr	0.000	+	0.000 = 0.000 hrs
				= 0.00 minutes
20. Watershed or subarea T <sub>c</sub> or T <sub>t</sub> (add T <sub>t</sub> in steps 6, 11, and 19) .....				19.229 hrs
				1153.75 minutes
Value used for Analysis (Minimum T <sub>c</sub> 0.10 hours) .....				19.23 hrs

Reference: 210-VI-TR-55, Second Ed., June 1986

### Worksheet 3: Time of concentration (Tc) or travel time (Tt)

Project: False River By: JMS Date: 3/3/2013  
 Location: Pointe Coupee Parish Checked: \_\_\_\_\_ Date: \_\_\_\_\_

Check One: Present  Developed \_\_\_\_\_ M1-06  
 Check One: T<sub>c</sub>  T<sub>t</sub> \_\_\_\_\_ Existing

Notes: Space for as many as two segments per flow type can be used for each worksheet.  
 Include a map, schematic, or description of flow segments.

#### Sheet Flow (Applicable to T<sub>c</sub> only)

	Segment ID	A	n/a	
1. Surface Description (Table 3-1) .....		Grass		
2. Manning's roughness coeff., n (Table 3-1) .....		0.150		
3. Flow length, L (total L ≤ 300 ft) .....	ft.	300.0		
4. Two-yr 24-hr rainfall, P <sub>2</sub> .....	in.	4.80		
5. Land Slope, s .....	ft. / ft.	0.00431		
6. T <sub>t</sub> = $\frac{0.007 (nL)^{0.8}}{(P_2^{0.5} s^{0.4})}$ .....	hr	0.593	+	0.000 = 0.593 hrs.
				= 35.60 minutes

#### Shallow concentrated flow

	Segment ID	B	n/a	
7. Surface description (paved or unpaved) .....		Unpaved		
8. Flow length, L .....	ft.	13,890.0		
9. Watercourse slope, s .....	ft. / ft.	0.00130		
10. Average velocity, V (figure 3-1) .....	ft. / s	0.581		
11. T <sub>t</sub> = $\frac{L}{3600 V}$ .....	hr	6.638	+	0.000 = 6.638 hrs.
				= 398.25 minutes

#### Channel flow

	Segment ID	C	n/a	
12. Cross sectional flow area, a .....	ft <sup>2</sup>	425.2		
13. Wetted perimeter, P <sub>w</sub> .....	ft.	71.7		
14. Hydraulic radius, r = $\frac{a}{P_w}$ .....	ft.	5.9		
15. Channel slope, s .....	ft. / ft.	0.00034		
16. Manning's roughness coeff., n .....		0.035		
17. V = $\frac{1.49 r^{2/3} s^{1/2}}{n}$ .....	ft. / s.	2.564		
18. Flow length, L .....	ft.	2,459.3		
19. T <sub>t</sub> = $\frac{L}{3600 V}$ .....	hr	0.266	+	0.000 = 0.266 hrs
				= 15.98 minutes
20. Watershed or subarea T <sub>c</sub> or T <sub>t</sub> (add T <sub>t</sub> in steps 6, 11, and 19) .....		7.497		hrs
		449.84		minutes
Value used for Analysis (Minimum T <sub>c</sub> 0.10 hours) .....		7.50		hrs

Reference: 210-VI-TR-55, Second Ed., June 1986

### Worksheet 3: Time of concentration (Tc) or travel time (Tt)

Project: False River By: JMS Date: 3/3/2013  
 Location: Pointe Coupee Parish Checked: \_\_\_\_\_ Date: \_\_\_\_\_

Check One: Present  Developed \_\_\_\_\_ M1-07  
 Check One: T<sub>c</sub>  T<sub>t</sub> \_\_\_\_\_ Existing

Notes: Space for as many as two segments per flow type can be used for each worksheet.  
 Include a map, schematic, or description of flow segments.

#### Sheet Flow (Applicable to T<sub>c</sub> only)

	Segment ID	A	n/a	
1. Surface Description (Table 3-1) .....		Grass		
2. Manning's roughness coeff., n (Table 3-1) .....		0.150		
3. Flow length, L (total L ≤ 300 ft) .....	ft.	300.0		
4. Two-yr 24-hr rainfall, P <sub>2</sub> .....	in.	4.80		
5. Land Slope, s .....	ft. / ft.	0.00235		
6. T <sub>t</sub> = $\frac{0.007 (nL)^{0.8}}{(P_2^{0.5} s^{0.4})}$ .....	hr	0.756	+	0.000 = 0.756 hrs.
				= 45.39 minutes

#### Shallow concentrated flow

	Segment ID	B	n/a	
7. Surface description (paved or unpaved) .....		Unpaved		
8. Flow length, L .....	ft.	11,053.5		
9. Watercourse slope, s .....	ft. / ft.	0.00144		
10. Average velocity, V (figure 3-1) .....	ft. / s	0.612		
11. T <sub>t</sub> = $\frac{L}{3600 V}$ .....	hr	5.017	+	0.000 = 5.017 hrs.
				= 301.00 minutes

#### Channel flow

	Segment ID	C	n/a	
12. Cross sectional flow area, a .....	ft <sup>2</sup>	468.9		
13. Wetted perimeter, P <sub>w</sub> .....	ft.	75.1		
14. Hydraulic radius, r = $\frac{a}{P_w}$ .....	ft.	6.2		
15. Channel slope, s .....	ft. / ft.	0.00010		
16. Manning's roughness coeff., n .....		0.035		
17. V = $\frac{1.49 r^{2/3} s^{1/2}}{n}$ .....	ft. / s.	1.443		
18. Flow length, L .....	ft.	4,698.8		
19. T <sub>t</sub> = $\frac{L}{3600 V}$ .....	hr	0.904	+	0.000 = 0.904 hrs
				= 54.25 minutes
20. Watershed or subarea T <sub>c</sub> or T <sub>t</sub> (add T <sub>t</sub> in steps 6, 11, and 19) .....		6.677	hrs	
		400.64	minutes	
Value used for Analysis (Minimum T <sub>c</sub> 0.10 hours) .....		6.68	hrs	

Reference: 210-VI-TR-55, Second Ed., June 1986

### Worksheet 3: Time of concentration (Tc) or travel time (Tt)

Project: False River By: JMS Date: 3/3/2013  
 Location: Pointe Coupee Parish Checked: \_\_\_\_\_ Date: \_\_\_\_\_

Check One: Present  Developed \_\_\_\_\_ M1-08  
 Check One: T<sub>c</sub>  T<sub>t</sub> \_\_\_\_\_ Existing

Notes: Space for as many as two segments per flow type can be used for each worksheet.  
 Include a map, schematic, or description of flow segments.

#### Sheet Flow (Applicable to T<sub>c</sub> only)

	Segment ID	A	n/a	
1. Surface Description (Table 3-1) .....		Cultivated Soil		
2. Manning's roughness coeff., n (Table 3-1) .....		0.170		
3. Flow length, L (total L ≤ 300 ft) .....	ft.	300.0		
4. Two-yr 24-hr rainfall, P <sub>2</sub> .....	in.	4.80		
5. Land Slope, s .....	ft. / ft.	0.00103		
6. T <sub>t</sub> = $\frac{0.007 (nL)^{0.8}}{(P_2^{0.5} s^{0.4})}$ .....	hr	1.164	+ 0.000	= 1.164 hrs.
				= 69.86 minutes

#### Shallow concentrated flow

	Segment ID	B	n/a	
7. Surface description (paved or unpaved) .....		Unpaved		
8. Flow length, L .....	ft.	4,508.1		
9. Watercourse slope, s .....	ft. / ft.	0.00010		
10. Average velocity, V (figure 3-1) .....	ft. / s	0.161		
11. T <sub>t</sub> = $\frac{L}{3600 V}$ .....	hr	7.761	+ 0.000	= 7.761 hrs.
				= 465.68 minutes

#### Channel flow

	Segment ID	n/a	n/a	
12. Cross sectional flow area, a .....	ft <sup>2</sup>	0.0		
13. Wetted perimeter, P <sub>w</sub> .....	ft.	0.0		
14. Hydraulic radius, r = $\frac{a}{P_w}$ .....	ft.			
15. Channel slope, s .....	ft. / ft.	0.00010		
16. Manning's roughness coeff., n .....				
17. V = $\frac{1.49 r^{2/3} s^{1/2}}{n}$ .....	ft. / s.			
18. Flow length, L .....	ft.	0.0		
19. T <sub>t</sub> = $\frac{L}{3600 V}$ .....	hr	0.000	+ 0.000	= 0.000 hrs
				= 0.00 minutes
20. Watershed or subarea T <sub>c</sub> or T <sub>t</sub> (add T <sub>t</sub> in steps 6, 11, and 19) .....		8.926	hrs	
		535.54	minutes	
Value used for Analysis (Minimum T <sub>c</sub> 0.10 hours) .....		8.93	hrs	

Reference: 210-VI-TR-55, Second Ed., June 1986

### Worksheet 3: Time of concentration (Tc) or travel time (Tt)

Project: False River By: JMS Date: 3/3/2013  
 Location: Pointe Coupee Parish Checked: \_\_\_\_\_ Date: \_\_\_\_\_

Check One: Present  Developed \_\_\_\_\_ M1-09  
 Check One: T<sub>c</sub>  T<sub>t</sub> \_\_\_\_\_ Existing

Notes: Space for as many as two segments per flow type can be used for each worksheet.  
 Include a map, schematic, or description of flow segments.

#### Sheet Flow (Applicable to T<sub>c</sub> only)

	Segment ID	A	n/a	
1. Surface Description (Table 3-1) .....		Grass		
2. Manning's roughness coeff., n (Table 3-1) .....		0.150		
3. Flow length, L (total L ≤ 300 ft) .....	ft.	300.0		
4. Two-yr 24-hr rainfall, P <sub>2</sub> .....	in.	4.80		
5. Land Slope, s .....	ft. / ft.	0.00214		
6. T <sub>t</sub> = $\frac{0.007 (nL)^{0.8}}{(P_2^{0.5} s^{0.4})}$ .....	hr	0.786	+	0.000 = 0.786 hrs.
				= 47.14 minutes

#### Shallow concentrated flow

	Segment ID	B	n/a	
7. Surface description (paved or unpaved) .....		Unpaved		
8. Flow length, L .....	ft.	10,392.0		
9. Watercourse slope, s .....	ft. / ft.	0.00156		
10. Average velocity, V (figure 3-1) .....	ft. / s	0.636		
11. T <sub>t</sub> = $\frac{L}{3600 V}$ .....	hr	4.537	+	0.000 = 4.537 hrs.
				= 272.23 minutes

#### Channel flow

	Segment ID	n/a	n/a	
12. Cross sectional flow area, a .....	ft <sup>2</sup>	0.0		
13. Wetted perimeter, P <sub>w</sub> .....	ft.	0.0		
14. Hydraulic radius, r = $\frac{a}{P_w}$ .....	ft.			
15. Channel slope, s .....	ft. / ft.	0.00010		
16. Manning's roughness coeff., n .....				
17. V = $\frac{1.49 r^{2/3} s^{1/2}}{n}$ .....	ft. / s.			
18. Flow length, L .....	ft.	0.0		
19. T <sub>t</sub> = $\frac{L}{3600 V}$ .....	hr	0.000	+	0.000 = 0.000 hrs
				= 0.00 minutes
20. Watershed or subarea T <sub>c</sub> or T <sub>t</sub> (add T <sub>t</sub> in steps 6, 11, and 19) .....		5.323	hrs	
		319.36	minutes	
Value used for Analysis (Minimum T <sub>c</sub> 0.10 hours) .....		5.32	hrs	

Reference: 210-VI-TR-55, Second Ed., June 1986

### Worksheet 3: Time of concentration (Tc) or travel time (Tt)

Project: False River By: JMS Date: 3/3/2013  
 Location: Pointe Coupee Parish Checked: \_\_\_\_\_ Date: \_\_\_\_\_

Check One: Present  Developed \_\_\_\_\_ M1-10  
 Check One: T<sub>c</sub>  T<sub>t</sub> \_\_\_\_\_ Existing

Notes: Space for as many as two segments per flow type can be used for each worksheet.  
 Include a map, schematic, or description of flow segments.

#### Sheet Flow (Applicable to T<sub>c</sub> only)

	Segment ID	A	n/a	
1. Surface Description (Table 3-1) .....		Light Underbrush		
2. Manning's roughness coeff., n (Table 3-1) .....		0.400		
3. Flow length, L (total L ≤ 300 ft) .....	ft.	300.0		
4. Two-yr 24-hr rainfall, P <sub>2</sub> .....	in.	4.80		
5. Land Slope, s .....	ft. / ft.	0.00741		
6. T <sub>t</sub> = $\frac{0.007 (nL)^{0.8}}{(P_2^{0.5} s^{0.4})}$ .....	hr	1.047	+	0.000 = 1.047 hrs.
				= 62.80 minutes

#### Shallow concentrated flow

	Segment ID	B	n/a	
7. Surface description (paved or unpaved) .....		Unpaved		
8. Flow length, L .....	ft.	11,893.2		
9. Watercourse slope, s .....	ft. / ft.	0.00071		
10. Average velocity, V (figure 3-1) .....	ft. / s	0.430		
11. T <sub>t</sub> = $\frac{L}{3600 V}$ .....	hr	7.679	+	0.000 = 7.679 hrs.
				= 460.74 minutes

#### Channel flow

	Segment ID	n/a	n/a	
12. Cross sectional flow area, a .....	ft <sup>2</sup>	0.0		
13. Wetted perimeter, P <sub>w</sub> .....	ft.	0.0		
14. Hydraulic radius, r = $\frac{a}{P_w}$ .....	ft.			
15. Channel slope, s .....	ft. / ft.	0.00010		
16. Manning's roughness coeff., n .....				
17. V = $\frac{1.49 r^{2/3} s^{1/2}}{n}$ .....	ft. / s.			
18. Flow length, L .....	ft.	0.0		
19. T <sub>t</sub> = $\frac{L}{3600 V}$ .....	hr	0.000	+	0.000 = 0.000 hrs
				= 0.00 minutes
20. Watershed or subarea T <sub>c</sub> or T <sub>t</sub> (add T <sub>t</sub> in steps 6, 11, and 19) .....		8.726		hrs
		523.54		minutes
Value used for Analysis (Minimum T <sub>c</sub> 0.10 hours) .....		8.73		hrs

Reference: 210-VI-TR-55, Second Ed., June 1986



### Worksheet 3: Time of concentration (Tc) or travel time (Tt)

Project: False River By: JMS Date: 3/3/2013  
 Location: Pointe Coupee Parish Checked: \_\_\_\_\_ Date: \_\_\_\_\_

Check One: Present  Developed \_\_\_\_\_ M1-11  
 Check One: T<sub>c</sub>  T<sub>t</sub> \_\_\_\_\_ Existing

Notes: Space for as many as two segments per flow type can be used for each worksheet.  
 Include a map, schematic, or description of flow segments.

#### Sheet Flow (Applicable to T<sub>c</sub> only)

	Segment ID	A	n/a	
1. Surface Description (Table 3-1) .....		Grass		
2. Manning's roughness coeff., n (Table 3-1) .....		0.150		
3. Flow length, L (total L ≤ 300 ft) .....	ft.	300.0		
4. Two-yr 24-hr rainfall, P <sub>2</sub> .....	in.	4.80		
5. Land Slope, s .....	ft. / ft.	0.00439		
6. T <sub>t</sub> = $\frac{0.007 (nL)^{0.8}}{(P_2^{0.5} s^{0.4})}$ .....	hr	0.589	+	0.000 = 0.589 hrs.
				= 35.33 minutes

#### Shallow concentrated flow

	Segment ID	B	n/a	
7. Surface description (paved or unpaved) .....		Unpaved		
8. Flow length, L .....	ft.	5,177.4		
9. Watercourse slope, s .....	ft. / ft.	0.00249		
10. Average velocity, V (figure 3-1) .....	ft. / s	0.805		
11. T <sub>t</sub> = $\frac{L}{3600 V}$ .....	hr	1.787	+	0.000 = 1.787 hrs.
				= 107.24 minutes

#### Channel flow

	Segment ID	C	n/a	
12. Cross sectional flow area, a .....	ft <sup>2</sup>	608.3		
13. Wetted perimeter, P <sub>w</sub> .....	ft.	83.7		
14. Hydraulic radius, $r = \frac{a}{P_w}$ .....	ft.	7.3		
15. Channel slope, s .....	ft. / ft.	0.00011		
16. Manning's roughness coeff., n .....		0.035		
17. $V = \frac{1.49 r^{2/3} s^{1/2}}{n}$ .....	ft. / s.	1.691		
18. Flow length, L .....	ft.	6,380.3		
19. T <sub>t</sub> = $\frac{L}{3600 V}$ .....	hr	1.048	+	0.000 = 1.048 hrs
				= 62.90 minutes
20. Watershed or subarea T <sub>c</sub> or T <sub>t</sub> (add T <sub>t</sub> in steps 6, 11, and 19) .....		3.425		hrs
		205.47		minutes
Value used for Analysis (Minimum T <sub>c</sub> 0.10 hours) .....		3.42		hrs

Reference: 210-VI-TR-55, Second Ed., June 1986

### Worksheet 3: Time of concentration (Tc) or travel time (Tt)

Project: False River By: JMS Date: 6/19/2015  
 Location: Pointe Coupee Parish Checked: \_\_\_\_\_ Date: \_\_\_\_\_

Check One: Present  Developed \_\_\_\_\_ N-01  
 Check One: T<sub>c</sub>  T<sub>t</sub> \_\_\_\_\_ Existing

Notes: Space for as many as two segments per flow type can be used for each worksheet.  
 Include a map, schematic, or description of flow segments.

#### Sheet Flow (Applicable to T<sub>c</sub> only)

	Segment ID	A	n/a	
1. Surface Description (Table 3-1) .....		Grass		
2. Manning's roughness coeff., n (Table 3-1) .....		0.150		
3. Flow length, L (total L ≤ 300 ft) .....	ft.	300.0		
4. Two-yr 24-hr rainfall, P <sub>2</sub> .....	in.	4.80		
5. Land Slope, s .....	ft. / ft.	0.03888		
6. T <sub>t</sub> = $\frac{0.007 (nL)^{0.8}}{(P_2^{0.5} s^{0.4})}$ .....	hr	0.246	+	0.000 = 0.246 hrs.
				= 14.77 minutes

#### Shallow concentrated flow

	Segment ID	B	n/a	
7. Surface description (paved or unpaved) .....		Unpaved		
8. Flow length, L .....	ft.	3,121.2		
9. Watercourse slope, s .....	ft. / ft.	0.00242		
10. Average velocity, V (figure 3-1) .....	ft. / s	0.794		
11. T <sub>t</sub> = $\frac{L}{3600 V}$ .....	hr	1.092	+	0.000 = 1.092 hrs.
				= 65.51 minutes

#### Channel flow

	Segment ID	C	n/a	
12. Cross sectional flow area, a .....	ft <sup>2</sup>	1,273.4		
13. Wetted perimeter, P <sub>w</sub> .....	ft.	139.8		
14. Hydraulic radius, r = $\frac{a}{P_w}$ .....	ft.	9.1		
15. Channel slope, s .....	ft. / ft.	0.00036		
16. Manning's roughness coeff., n .....		0.035		
17. V = $\frac{1.49 r^{2/3} s^{1/2}}{n}$ .....	ft. / s.	3.524		
18. Flow length, L .....	ft.	19,395.5		
19. T <sub>t</sub> = $\frac{L}{3600 V}$ .....	hr	1.529	+	0.000 = 1.529 hrs
				= 91.73 minutes
20. Watershed or subarea T <sub>c</sub> or T <sub>t</sub> (add T <sub>t</sub> in steps 6, 11, and 19) .....		2.867		hrs
		172.02		minutes
Value used for Analysis (Minimum T <sub>c</sub> 0.10 hours) .....		2.87		hrs

Reference: 210-VI-TR-55, Second Ed., June 1986

### Worksheet 3: Time of concentration (Tc) or travel time (Tt)

Project: False River By: JMS Date: 6/19/2015  
 Location: Pointe Coupee Parish Checked: \_\_\_\_\_ Date: \_\_\_\_\_

Check One: Present X Developed \_\_\_\_\_  
 Check One: T<sub>c</sub> X T<sub>t</sub> \_\_\_\_\_  
N-01A  
Existing

Notes: Space for as many as two segments per flow type can be used for each worksheet.  
 Include a map, schematic, or description of flow segments.

#### Sheet Flow (Applicable to T<sub>c</sub> only)

	Segment ID	A	n/a	
1. Surface Description (Table 3-1) .....		Grass		
2. Manning's roughness coeff., n (Table 3-1) .....		0.150		
3. Flow length, L (total L ≤ 300 ft) .....	ft.	300.0		
4. Two-yr 24-hr rainfall, P <sub>2</sub> .....	in.	4.80		
5. Land Slope, s .....	ft. / ft.	0.05060		
6. T <sub>t</sub> = $\frac{0.007 (nL)^{0.8}}{(P_2^{0.5} s^{0.4})}$ .....	hr	0.222	+	0.000 = 0.222 hrs.
				= 13.29 minutes

#### Shallow concentrated flow

	Segment ID	B	n/a	
7. Surface description (paved or unpaved) .....		Unpaved		
8. Flow length, L .....	ft.	234.8		
9. Watercourse slope, s .....	ft. / ft.	0.03018		
10. Average velocity, V (figure 3-1) .....	ft. / s	2.803		
11. T <sub>t</sub> = $\frac{L}{3600 V}$ .....	hr	0.023	+	0.000 = 0.023 hrs.
				= 1.40 minutes

#### Channel flow

	Segment ID	C	n/a	
12. Cross sectional flow area, a .....	ft <sup>2</sup>	151.6		
13. Wetted perimeter, P <sub>w</sub> .....	ft.	5.6		
14. Hydraulic radius, r = $\frac{a}{P_w}$ .....	ft.	26.8		
15. Channel slope, s .....	ft. / ft.	0.00010		
16. Manning's roughness coeff., n .....		0.035		
17. V = $\frac{1.49 r^{2/3} s^{1/2}}{n}$ .....	ft. / s.	3.817		
18. Flow length, L .....	ft.	956.6		
19. T <sub>t</sub> = $\frac{L}{3600 V}$ .....	hr	0.070	+	0.000 = 0.070 hrs
				= 4.18 minutes
20. Watershed or subarea T <sub>c</sub> or T <sub>t</sub> (add T <sub>t</sub> in steps 6, 11, and 19) .....		0.314	hrs	
		18.86	minutes	
Value used for Analysis (Minimum T <sub>c</sub> 0.10 hours) .....		0.31	hrs	

Reference: 210-VI-TR-55, Second Ed., June 1986

### Worksheet 3: Time of concentration (Tc) or travel time (Tt)

Project: False River By: JMS Date: 6/19/2015  
 Location: Pointe Coupee Parish Checked: \_\_\_\_\_ Date: \_\_\_\_\_

Check One: Present  Developed \_\_\_\_\_ N-01B  
 Check One: T<sub>c</sub>  T<sub>t</sub> \_\_\_\_\_ Existing

Notes: Space for as many as two segments per flow type can be used for each worksheet.  
 Include a map, schematic, or description of flow segments.

#### Sheet Flow (Applicable to T<sub>c</sub> only)

	Segment ID	A	n/a	
1. Surface Description (Table 3-1) .....		Grass		
2. Manning's roughness coeff., n (Table 3-1) .....		0.150		
3. Flow length, L (total L ≤ 300 ft) .....	ft.	300.0		
4. Two-yr 24-hr rainfall, P <sub>2</sub> .....	in.	4.80		
5. Land Slope, s .....	ft. / ft.	0.00629		
6. T <sub>t</sub> = $\frac{0.007 (nL)^{0.8}}{(P_2^{0.5} s^{0.4})}$ .....	hr	0.510	+	0.000
			=	0.510 hrs.
			=	30.60 minutes

#### Shallow concentrated flow

	Segment ID	B	n/a	
7. Surface description (paved or unpaved) .....		Unpaved		
8. Flow length, L .....	ft.	1,658.1		
9. Watercourse slope, s .....	ft. / ft.	0.00778		
10. Average velocity, V (figure 3-1) .....	ft. / s	1.423		
11. T <sub>t</sub> = $\frac{L}{3600 V}$ .....	hr	0.324	+	0.000
			=	0.324 hrs.
			=	19.42 minutes

#### Channel flow

	Segment ID	C	n/a	
12. Cross sectional flow area, a .....	ft <sup>2</sup>	56.4		
13. Wetted perimeter, P <sub>w</sub> .....	ft.	5.8		
14. Hydraulic radius, r = $\frac{a}{P_w}$ .....	ft.	9.6		
15. Channel slope, s .....	ft. / ft.	0.00229		
16. Manning's roughness coeff., n .....		0.035		
17. V = $\frac{1.49 r^{2/3} s^{1/2}}{n}$ .....	ft. / s.	9.232		
18. Flow length, L .....	ft.	3,079.3		
19. T <sub>t</sub> = $\frac{L}{3600 V}$ .....	hr	0.093	+	0.000
			=	0.093 hrs
			=	5.56 minutes
20. Watershed or subarea T <sub>c</sub> or T <sub>t</sub> (add T <sub>t</sub> in steps 6, 11, and 19) .....		0.926		hrs
		55.58		minutes
Value used for Analysis (Minimum T <sub>c</sub> 0.10 hours) .....		0.93		hrs

Reference: 210-VI-TR-55, Second Ed., June 1986

### Worksheet 3: Time of concentration (Tc) or travel time (Tt)

Project: False River By: JMS Date: 3/3/2013  
 Location: Pointe Coupee Parish Checked: \_\_\_\_\_ Date: \_\_\_\_\_

Check One: Present  Developed \_\_\_\_\_ N-02  
 Check One: T<sub>c</sub>  T<sub>t</sub> \_\_\_\_\_ Existing

Notes: Space for as many as two segments per flow type can be used for each worksheet.  
 Include a map, schematic, or description of flow segments.

#### Sheet Flow (Applicable to T<sub>c</sub> only)

	Segment ID	A	n/a	
1. Surface Description (Table 3-1) .....		Grass		
2. Manning's roughness coeff., n (Table 3-1) .....		0.150		
3. Flow length, L (total L ≤ 300 ft) .....	ft.	300.0		
4. Two-yr 24-hr rainfall, P <sub>2</sub> .....	in.	4.80		
5. Land Slope, s .....	ft. / ft.	0.00155		
6. T <sub>t</sub> = $\frac{0.007 (nL)^{0.8}}{(P_2^{0.5} s^{0.4})}$ .....	hr	0.892	+	0.000 = 0.892 hrs.
				= 53.55 minutes

#### Shallow concentrated flow

	Segment ID	B	n/a	
7. Surface description (paved or unpaved) .....		Unpaved		
8. Flow length, L .....	ft.	11,365.0		
9. Watercourse slope, s .....	ft. / ft.	0.00014		
10. Average velocity, V (figure 3-1) .....	ft. / s	0.190		
11. T <sub>t</sub> = $\frac{L}{3600 V}$ .....	hr	16.596	+	0.000 = 16.596 hrs.
				= 995.77 minutes

#### Channel flow

	Segment ID	n/a	n/a	
12. Cross sectional flow area, a .....	ft <sup>2</sup>	0.0		
13. Wetted perimeter, P <sub>w</sub> .....	ft.	0.0		
14. Hydraulic radius, r = $\frac{a}{P_w}$ .....	ft.			
15. Channel slope, s .....	ft. / ft.	0.00010		
16. Manning's roughness coeff., n .....		0.035		
17. V = $\frac{1.49 r^{2/3} s^{1/2}}{n}$ .....	ft. / s.			
18. Flow length, L .....	ft.	0.0		
19. T <sub>t</sub> = $\frac{L}{3600 V}$ .....	hr	0.000	+	0.000 = 0.000 hrs
				= 0.00 minutes
20. Watershed or subarea T <sub>c</sub> or T <sub>t</sub> (add T <sub>t</sub> in steps 6, 11, and 19) .....		17.489	hrs	
		1049.31	minutes	
Value used for Analysis (Minimum T <sub>c</sub> 0.10 hours) .....		17.49	hrs	

Reference: 210-VI-TR-55, Second Ed., June 1986

### Worksheet 3: Time of concentration (Tc) or travel time (Tt)

Project: False River By: JMS Date: 3/3/2013  
 Location: Pointe Coupee Parish Checked: \_\_\_\_\_ Date: \_\_\_\_\_

Check One: Present  Developed \_\_\_\_\_ N-03  
 Check One: T<sub>c</sub>  T<sub>t</sub> \_\_\_\_\_ Existing

Notes: Space for as many as two segments per flow type can be used for each worksheet.  
 Include a map, schematic, or description of flow segments.

#### Sheet Flow (Applicable to T<sub>c</sub> only)

	Segment ID	A	n/a	
1. Surface Description (Table 3-1) .....		Fallow		
2. Manning's roughness coeff., n (Table 3-1) .....		0.050		
3. Flow length, L (total L ≤ 300 ft) .....	ft.	300.0		
4. Two-yr 24-hr rainfall, P <sub>2</sub> .....	in.	4.80		
5. Land Slope, s .....	ft. / ft.	0.00876		
6. T <sub>t</sub> = $\frac{0.007 (nL)^{0.8}}{(P_2^{0.5} s^{0.4})}$ .....	hr	0.186	+	0.000 = 0.186 hrs.
				= 11.13 minutes

#### Shallow concentrated flow

	Segment ID	B	n/a	
7. Surface description (paved or unpaved) .....		Unpaved		
8. Flow length, L .....	ft.	7,883.3		
9. Watercourse slope, s .....	ft. / ft.	0.00054		
10. Average velocity, V (figure 3-1) .....	ft. / s	0.375		
11. T <sub>t</sub> = $\frac{L}{3600 V}$ .....	hr	5.841	+	0.000 = 5.841 hrs.
				= 350.43 minutes

#### Channel flow

	Segment ID	C	n/a	
12. Cross sectional flow area, a .....	ft <sup>2</sup>	608.3		
13. Wetted perimeter, P <sub>w</sub> .....	ft.	83.7		
14. Hydraulic radius, r = $\frac{a}{P_w}$ .....	ft.	7.3		
15. Channel slope, s .....	ft. / ft.	0.00010		
16. Manning's roughness coeff., n .....		0.035		
17. V = $\frac{1.49 r^{2/3} s^{1/2}}{n}$ .....	ft. / s.	1.597		
18. Flow length, L .....	ft.	12,329.2		
19. T <sub>t</sub> = $\frac{L}{3600 V}$ .....	hr	2.144	+	0.000 = 2.144 hrs
				= 128.63 minutes
20. Watershed or subarea T <sub>c</sub> or T <sub>t</sub> (add T <sub>t</sub> in steps 6, 11, and 19) .....		8.170	hrs	
		490.20	minutes	
Value used for Analysis (Minimum T <sub>c</sub> 0.10 hours) .....		8.17	hrs	

Reference: 210-VI-TR-55, Second Ed., June 1986

### Worksheet 3: Time of concentration (Tc) or travel time (Tt)

Project: False River By: JMS Date: 3/3/2013  
 Location: Pointe Coupee Parish Checked: \_\_\_\_\_ Date: \_\_\_\_\_

Check One: Present X Developed \_\_\_\_\_ N-04  
 Check One: T<sub>c</sub> X T<sub>t</sub> \_\_\_\_\_ Existing

Notes: Space for as many as two segments per flow type can be used for each worksheet.  
 Include a map, schematic, or description of flow segments.

#### Sheet Flow (Applicable to T<sub>c</sub> only)

	Segment ID	A	n/a	
1. Surface Description (Table 3-1) .....		Cultivated Soil		
2. Manning's roughness coeff., n (Table 3-1) .....		0.170		
3. Flow length, L (total L ≤ 300 ft) .....	ft.	300.0		
4. Two-yr 24-hr rainfall, P <sub>2</sub> .....	in.	4.80		
5. Land Slope, s .....	ft. / ft.	0.00010		
6. T <sub>t</sub> = $\frac{0.007 (nL)^{0.8}}{(P_2^{0.5} s^{0.4})}$ .....	hr	2.955	+ 0.000	= 2.955 hrs.
				= 177.29 minutes

#### Shallow concentrated flow

	Segment ID	B	n/a	
7. Surface description (paved or unpaved) .....		Unpaved		
8. Flow length, L .....	ft.	6,656.9		
9. Watercourse slope, s .....	ft. / ft.	0.00200		
10. Average velocity, V (figure 3-1) .....	ft. / s	0.722		
11. T <sub>t</sub> = $\frac{L}{3600 V}$ .....	hr	2.561	+ 0.000	= 2.561 hrs.
				= 153.68 minutes

#### Channel flow

	Segment ID	n/a	n/a	
12. Cross sectional flow area, a .....	ft <sup>2</sup>	0.0		
13. Wetted perimeter, P <sub>w</sub> .....	ft.	0.0		
14. Hydraulic radius, $r = \frac{a}{P_w}$ .....	ft.			
15. Channel slope, s .....	ft. / ft.	0.00010		
16. Manning's roughness coeff., n .....		0.035		
17. $V = \frac{1.49 r^{2/3} s^{1/2}}{n}$ .....	ft. / s.			
18. Flow length, L .....	ft.	0.0		
19. T <sub>t</sub> = $\frac{L}{3600 V}$ .....	hr	0.000	+ 0.000	= 0.000 hrs
				= 0.00 minutes
20. Watershed or subarea T <sub>c</sub> or T <sub>t</sub> (add T <sub>t</sub> in steps 6, 11, and 19) .....		5.516	hrs	
		330.97	minutes	
Value used for Analysis (Minimum T <sub>c</sub> 0.10 hours) .....		5.52	hrs	

Reference: 210-VI-TR-55, Second Ed., June 1986

### Worksheet 3: Time of concentration (Tc) or travel time (Tt)

Project: False River By: JMS Date: 3/3/2013  
 Location: Pointe Coupee Parish Checked: \_\_\_\_\_ Date: \_\_\_\_\_

Check One: Present  Developed \_\_\_\_\_ N-05  
 Check One: T<sub>c</sub>  T<sub>t</sub> \_\_\_\_\_ Existing

Notes: Space for as many as two segments per flow type can be used for each worksheet.  
 Include a map, schematic, or description of flow segments.

#### Sheet Flow (Applicable to T<sub>c</sub> only)

	Segment ID	A	n/a	
1. Surface Description (Table 3-1) .....		Cultivated Soil		
2. Manning's roughness coeff., n (Table 3-1) .....		0.170		
3. Flow length, L (total L ≤ 300 ft) .....	ft.	300.0		
4. Two-yr 24-hr rainfall, P <sub>2</sub> .....	in.	4.80		
5. Land Slope, s .....	ft. / ft.	0.07668		
6. T <sub>t</sub> = $\frac{0.007 (nL)^{0.8}}{(P_2^{0.5} s^{0.4})}$ .....	hr	0.207	+	0.000 = 0.207 hrs.
				= 12.44 minutes

#### Shallow concentrated flow

	Segment ID	B	n/a	
7. Surface description (paved or unpaved) .....		Unpaved		
8. Flow length, L .....	ft.	8,996.7		
9. Watercourse slope, s .....	ft. / ft.	0.00115		
10. Average velocity, V (figure 3-1) .....	ft. / s	0.547		
11. T <sub>t</sub> = $\frac{L}{3600 V}$ .....	hr	4.569	+	0.000 = 4.569 hrs.
				= 274.17 minutes

#### Channel flow

	Segment ID	n/a	n/a	
12. Cross sectional flow area, a .....	ft <sup>2</sup>	0.0		
13. Wetted perimeter, P <sub>w</sub> .....	ft.	0.0		
14. Hydraulic radius, r = $\frac{a}{P_w}$ .....	ft.			
15. Channel slope, s .....	ft. / ft.	0.00010		
16. Manning's roughness coeff., n .....		0.035		
17. V = $\frac{1.49 r^{2/3} s^{1/2}}{n}$ .....	ft. / s.			
18. Flow length, L .....	ft.	0.0		
19. T <sub>t</sub> = $\frac{L}{3600 V}$ .....	hr	0.000	+	0.000 = 0.000 hrs
				= 0.00 minutes
20. Watershed or subarea T <sub>c</sub> or T <sub>t</sub> (add T <sub>t</sub> in steps 6, 11, and 19) .....		4.777		hrs
		286.61		minutes
Value used for Analysis (Minimum T <sub>c</sub> 0.10 hours) .....		4.78		hrs

Reference: 210-VI-TR-55, Second Ed., June 1986



### Worksheet 3: Time of concentration (Tc) or travel time (Tt)

Project: False River By: JMS Date: 3/3/2013  
 Location: Pointe Coupee Parish Checked: \_\_\_\_\_ Date: \_\_\_\_\_

Check One: Present  Developed \_\_\_\_\_ N-06  
 Check One: T<sub>c</sub>  T<sub>t</sub> \_\_\_\_\_ Existing

Notes: Space for as many as two segments per flow type can be used for each worksheet.  
 Include a map, schematic, or description of flow segments.

#### Sheet Flow (Applicable to T<sub>c</sub> only)

	Segment ID	A	n/a	
1. Surface Description (Table 3-1) .....		Grass		
2. Manning's roughness coeff., n (Table 3-1) .....		0.150		
3. Flow length, L (total L ≤ 300 ft) .....	ft.	300.0		
4. Two-yr 24-hr rainfall, P <sub>2</sub> .....	in.	4.80		
5. Land Slope, s .....	ft. / ft.	0.00479		
6. T <sub>t</sub> = $\frac{0.007 (nL)^{0.8}}{(P_2^{0.5} s^{0.4})}$ .....	hr	0.569	+	0.000 = 0.569 hrs.
				= 34.14 minutes

#### Shallow concentrated flow

	Segment ID	B	n/a	
7. Surface description (paved or unpaved) .....		Unpaved		
8. Flow length, L .....	ft.	7,223.3		
9. Watercourse slope, s .....	ft. / ft.	0.00026		
10. Average velocity, V (figure 3-1) .....	ft. / s	0.260		
11. T <sub>t</sub> = $\frac{L}{3600 V}$ .....	hr	7.712	+	0.000 = 7.712 hrs.
				= 462.75 minutes

#### Channel flow

	Segment ID	C	n/a	
12. Cross sectional flow area, a .....	ft <sup>2</sup>	608.3		
13. Wetted perimeter, P <sub>w</sub> .....	ft.	83.7		
14. Hydraulic radius, r = $\frac{a}{P_w}$ .....	ft.	7.3		
15. Channel slope, s .....	ft. / ft.	0.00046		
16. Manning's roughness coeff., n .....		0.035		
17. V = $\frac{1.49 r^{2/3} s^{1/2}}{n}$ .....	ft. / s.	3.419		
18. Flow length, L .....	ft.	4,250.5		
19. T <sub>t</sub> = $\frac{L}{3600 V}$ .....	hr	0.345	+	0.000 = 0.345 hrs
				= 20.72 minutes
20. Watershed or subarea T <sub>c</sub> or T <sub>t</sub> (add T <sub>t</sub> in steps 6, 11, and 19) .....		8.627		hrs
		517.61		minutes
Value used for Analysis (Minimum T <sub>c</sub> 0.10 hours) .....		8.63		hrs

Reference: 210-VI-TR-55, Second Ed., June 1986

### Worksheet 3: Time of concentration (Tc) or travel time (Tt)

Project: False River By: JMS Date: 3/3/2013  
 Location: Pointe Coupee Parish Checked: \_\_\_\_\_ Date: \_\_\_\_\_

Check One: Present  Developed \_\_\_\_\_ N-07  
 Check One: T<sub>c</sub>  T<sub>t</sub> \_\_\_\_\_ Existing

Notes: Space for as many as two segments per flow type can be used for each worksheet.  
 Include a map, schematic, or description of flow segments.

#### Sheet Flow (Applicable to T<sub>c</sub> only)

	Segment ID	A	n/a		
1. Surface Description (Table 3-1) .....		Grass			
2. Manning's roughness coeff., n (Table 3-1) .....		0.150			
3. Flow length, L (total L ≤ 300 ft) .....	ft.	300.0			
4. Two-yr 24-hr rainfall, P <sub>2</sub> .....	in.	4.80			
5. Land Slope, s .....	ft. / ft.	0.00010			
6. T <sub>t</sub> = $\frac{0.007 (nL)^{0.8}}{(P_2^{0.5} s^{0.4})}$ .....	hr	2.673	+	0.000	= 2.673 hrs.
					= 160.40 minutes

#### Shallow concentrated flow

	Segment ID	n/a	n/a		
7. Surface description (paved or unpaved) .....					
8. Flow length, L .....	ft.	0.0			
9. Watercourse slope, s .....	ft. / ft.	0.00010			
10. Average velocity, V (figure 3-1) .....	ft. / s				
11. T <sub>t</sub> = $\frac{L}{3600 V}$ .....	hr	0.000	+	0.000	= 0.000 hrs.
					= 0.00 minutes

#### Channel flow

	Segment ID	C	n/a		
12. Cross sectional flow area, a .....	ft <sup>2</sup>	608.3			
13. Wetted perimeter, P <sub>w</sub> .....	ft.	83.7			
14. Hydraulic radius, $r = \frac{a}{P_w}$ .....	ft.	7.3			
15. Channel slope, s .....	ft. / ft.	0.00010			
16. Manning's roughness coeff., n .....		0.035			
17. V = $\frac{1.49 r^{2/3} s^{1/2}}{n}$ .....	ft. / s.	1.597			
18. Flow length, L .....	ft.	11,134.7			
19. T <sub>t</sub> = $\frac{L}{3600 V}$ .....	hr	1.936	+	0.000	= 1.936 hrs
					= 116.17 minutes
20. Watershed or subarea T <sub>c</sub> or T <sub>t</sub> (add T <sub>t</sub> in steps 6, 11, and 19) .....		4.609			hrs
		276.57			minutes
Value used for Analysis (Minimum T <sub>c</sub> 0.10 hours) .....		4.61			hrs

Reference: 210-VI-TR-55, Second Ed., June 1986

### Worksheet 3: Time of concentration (Tc) or travel time (Tt)

Project: False River By: JMS Date: 3/3/2013  
 Location: Pointe Coupee Parish Checked: \_\_\_\_\_ Date: \_\_\_\_\_

Check One: Present  Developed \_\_\_\_\_ W-01  
 Check One: T<sub>c</sub>  T<sub>t</sub> \_\_\_\_\_ Existing

Notes: Space for as many as two segments per flow type can be used for each worksheet.  
 Include a map, schematic, or description of flow segments.

#### Sheet Flow (Applicable to T<sub>c</sub> only)

	Segment ID	A	n/a	
1. Surface Description (Table 3-1) .....		Grass		
2. Manning's roughness coeff., n (Table 3-1) .....		0.150		
3. Flow length, L (total L ≤ 300 ft) .....	ft.	300.0		
4. Two-yr 24-hr rainfall, P <sub>2</sub> .....	in.	4.80		
5. Land Slope, s .....	ft. / ft.	0.00010		
6. T <sub>t</sub> = $\frac{0.007 (nL)^{0.8}}{(P_2^{0.5} s^{0.4})}$ .....	hr	2.673	+	0.000 = 2.673 hrs.
				= 160.40 minutes

#### Shallow concentrated flow

	Segment ID	B	n/a	
7. Surface description (paved or unpaved) .....		Unpaved		
8. Flow length, L .....	ft.	14,918.3		
9. Watercourse slope, s .....	ft. / ft.	0.00083		
10. Average velocity, V (figure 3-1) .....	ft. / s	0.466		
11. T <sub>t</sub> = $\frac{L}{3600 V}$ .....	hr	8.894	+	0.000 = 8.894 hrs.
				= 533.62 minutes

#### Channel flow

	Segment ID	n/a	n/a	
12. Cross sectional flow area, a .....	ft <sup>2</sup>	0.0		
13. Wetted perimeter, P <sub>w</sub> .....	ft.	0.0		
14. Hydraulic radius, r = $\frac{a}{P_w}$ .....	ft.			
15. Channel slope, s .....	ft. / ft.	0.00010		
16. Manning's roughness coeff., n .....		0.035		
17. V = $\frac{1.49 r^{2/3} s^{1/2}}{n}$ .....	ft. / s.			
18. Flow length, L .....	ft.	0.0		
19. T <sub>t</sub> = $\frac{L}{3600 V}$ .....	hr	0.000	+	0.000 = 0.000 hrs
				= 0.00 minutes
20. Watershed or subarea T <sub>c</sub> or T <sub>t</sub> (add T <sub>t</sub> in steps 6, 11, and 19) .....				11.567 hrs
				694.01 minutes
Value used for Analysis (Minimum T <sub>c</sub> 0.10 hours) .....				11.57 hrs

Reference: 210-VI-TR-55, Second Ed., June 1986

### Worksheet 3: Time of concentration (Tc) or travel time (Tt)

Project: False River By: JMS Date: 3/3/2013  
 Location: Pointe Coupee Parish Checked: \_\_\_\_\_ Date: \_\_\_\_\_

Check One: Present  Developed \_\_\_\_\_ W-02  
 Check One: T<sub>c</sub>  T<sub>t</sub> \_\_\_\_\_ Existing

Notes: Space for as many as two segments per flow type can be used for each worksheet.  
 Include a map, schematic, or description of flow segments.

#### Sheet Flow (Applicable to T<sub>c</sub> only)

	Segment ID	A	n/a	
1. Surface Description (Table 3-1) .....		Light Underbrush		
2. Manning's roughness coeff., n (Table 3-1) .....		0.400		
3. Flow length, L (total L ≤ 300 ft) .....	ft.	300.0		
4. Two-yr 24-hr rainfall, P <sub>2</sub> .....	in.	4.80		
5. Land Slope, s .....	ft. / ft.	0.00010		
6. T <sub>t</sub> = $\frac{0.007 (nL)^{0.8}}{(P_2^{0.5} s^{0.4})}$ .....	hr	5.859	+	0.000 = 5.859 hrs.
				= 351.54 minutes

#### Shallow concentrated flow

	Segment ID	B	n/a	
7. Surface description (paved or unpaved) .....		Unpaved		
8. Flow length, L .....	ft.	18,018.9		
9. Watercourse slope, s .....	ft. / ft.	0.00091		
10. Average velocity, V (figure 3-1) .....	ft. / s	0.487		
11. T <sub>t</sub> = $\frac{L}{3600 V}$ .....	hr	10.272	+	0.000 = 10.272 hrs.
				= 616.34 minutes

#### Channel flow

	Segment ID	C	n/a	
12. Cross sectional flow area, a .....	ft <sup>2</sup>	230.1		
13. Wetted perimeter, P <sub>w</sub> .....	ft.	55.9		
14. Hydraulic radius, r = $\frac{a}{P_w}$ .....	ft.	4.1		
15. Channel slope, s .....	ft. / ft.	0.00010		
16. Manning's roughness coeff., n .....		0.035		
17. V = $\frac{1.49 r^{2/3} s^{1/2}}{n}$ .....	ft. / s.	1.093		
18. Flow length, L .....	ft.	1,654.9		
19. T <sub>t</sub> = $\frac{L}{3600 V}$ .....	hr	0.420	+	0.000 = 0.420 hrs
				= 25.23 minutes
20. Watershed or subarea T <sub>c</sub> or T <sub>t</sub> (add T <sub>t</sub> in steps 6, 11, and 19) .....		16.552	hrs	
		993.11	minutes	
Value used for Analysis (Minimum T <sub>c</sub> 0.10 hours) .....		16.55	hrs	

Reference: 210-VI-TR-55, Second Ed., June 1986

### Worksheet 3: Time of concentration (Tc) or travel time (Tt)

Project: False River By: JMS Date: 3/3/2013  
 Location: Pointe Coupee Parish Checked: \_\_\_\_\_ Date: \_\_\_\_\_

Check One: Present  Developed \_\_\_\_\_ W-03  
 Check One: T<sub>c</sub>  T<sub>t</sub> \_\_\_\_\_ Existing

Notes: Space for as many as two segments per flow type can be used for each worksheet.  
 Include a map, schematic, or description of flow segments.

#### Sheet Flow (Applicable to T<sub>c</sub> only)

	Segment ID	A	n/a	
1. Surface Description (Table 3-1) .....		Grass		
2. Manning's roughness coeff., n (Table 3-1) .....		0.150		
3. Flow length, L (total L ≤ 300 ft) .....	ft.	300.0		
4. Two-yr 24-hr rainfall, P <sub>2</sub> .....	in.	4.80		
5. Land Slope, s .....	ft. / ft.	0.00805		
6. T <sub>t</sub> = $\frac{0.007 (nL)^{0.8}}{(P_2^{0.5} s^{0.4})}$ .....	hr	0.462	+	0.000 = 0.462 hrs.
				= 27.73 minutes

#### Shallow concentrated flow

	Segment ID	B	n/a	
7. Surface description (paved or unpaved) .....		Unpaved		
8. Flow length, L .....	ft.	15,369.8		
9. Watercourse slope, s .....	ft. / ft.	0.00101		
10. Average velocity, V (figure 3-1) .....	ft. / s	0.512		
11. T <sub>t</sub> = $\frac{L}{3600 V}$ .....	hr	8.335	+	0.000 = 8.335 hrs.
				= 500.07 minutes

#### Channel flow

	Segment ID	C	n/a	
12. Cross sectional flow area, a .....	ft <sup>2</sup>	230.1		
13. Wetted perimeter, P <sub>w</sub> .....	ft.	55.9		
14. Hydraulic radius, r = $\frac{a}{P_w}$ .....	ft.	4.1		
15. Channel slope, s .....	ft. / ft.	0.00010		
16. Manning's roughness coeff., n .....		0.035		
17. V = $\frac{1.49 r^{2/3} s^{1/2}}{n}$ .....	ft. / s.	1.093		
18. Flow length, L .....	ft.	3,726.1		
19. T <sub>t</sub> = $\frac{L}{3600 V}$ .....	hr	0.947	+	0.000 = 0.947 hrs
				= 56.80 minutes
20. Watershed or subarea T <sub>c</sub> or T <sub>t</sub> (add T <sub>t</sub> in steps 6, 11, and 19) .....				9.743 hrs
				584.60 minutes
Value used for Analysis (Minimum T <sub>c</sub> 0.10 hours) .....				9.74 hrs

Reference: 210-VI-TR-55, Second Ed., June 1986

### Worksheet 3: Time of concentration (Tc) or travel time (Tt)

Project: False River By: JMS Date: 3/3/2013  
 Location: Pointe Coupee Parish Checked: \_\_\_\_\_ Date: \_\_\_\_\_

Check One: Present  Developed \_\_\_\_\_ W-04  
 Check One: T<sub>c</sub>  T<sub>t</sub> \_\_\_\_\_ Existing

Notes: Space for as many as two segments per flow type can be used for each worksheet.  
 Include a map, schematic, or description of flow segments.

#### Sheet Flow (Applicable to T<sub>c</sub> only)

	Segment ID	A	n/a	
1. Surface Description (Table 3-1) .....		Grass		
2. Manning's roughness coeff., n (Table 3-1) .....		0.150		
3. Flow length, L (total L ≤ 300 ft) .....	ft.	300.0		
4. Two-yr 24-hr rainfall, P <sub>2</sub> .....	in.	4.80		
5. Land Slope, s .....	ft. / ft.	0.00876		
6. T <sub>t</sub> = $\frac{0.007 (nL)^{0.8}}{(P_2^{0.5} s^{0.4})}$ .....	hr	0.447	+	0.000 = 0.447 hrs.
				= 26.80 minutes

#### Shallow concentrated flow

	Segment ID	B	n/a	
7. Surface description (paved or unpaved) .....		Unpaved		
8. Flow length, L .....	ft.	585.7		
9. Watercourse slope, s .....	ft. / ft.	0.00519		
10. Average velocity, V (figure 3-1) .....	ft. / s	1.162		
11. T <sub>t</sub> = $\frac{L}{3600 V}$ .....	hr	0.140	+	0.000 = 0.140 hrs.
				= 8.40 minutes

#### Channel flow

	Segment ID	C	n/a	
12. Cross sectional flow area, a .....	ft <sup>2</sup>	230.1		
13. Wetted perimeter, P <sub>w</sub> .....	ft.	55.9		
14. Hydraulic radius, $r = \frac{a}{P_w}$ .....	ft.	4.1		
15. Channel slope, s .....	ft. / ft.	0.00090		
16. Manning's roughness coeff., n .....		0.035		
17. V = $\frac{1.49 r^{2/3} s^{1/2}}{n}$ .....	ft. / s.	3.273		
18. Flow length, L .....	ft.	5,956.4		
19. T <sub>t</sub> = $\frac{L}{3600 V}$ .....	hr	0.506	+	0.000 = 0.506 hrs
				= 30.33 minutes
20. Watershed or subarea T <sub>c</sub> or T <sub>t</sub> (add T <sub>t</sub> in steps 6, 11, and 19) .....		1.092		hrs
		65.53		minutes
Value used for Analysis (Minimum T <sub>c</sub> 0.10 hours) .....		1.09		hrs

Reference: 210-VI-TR-55, Second Ed., June 1986

### Worksheet 3: Time of concentration (Tc) or travel time (Tt)

Project: False River By: JMS Date: 3/3/2013  
 Location: Pointe Coupee Parish Checked: \_\_\_\_\_ Date: \_\_\_\_\_

Check One: Present  Developed \_\_\_\_\_ W-05  
 Check One: T<sub>c</sub>  T<sub>t</sub> \_\_\_\_\_ Existing

Notes: Space for as many as two segments per flow type can be used for each worksheet.  
 Include a map, schematic, or description of flow segments.

#### Sheet Flow (Applicable to T<sub>c</sub> only)

	Segment ID	A	n/a	
1. Surface Description (Table 3-1) .....		Grass		
2. Manning's roughness coeff., n (Table 3-1) .....		0.150		
3. Flow length, L (total L ≤ 300 ft) .....	ft.	300.0		
4. Two-yr 24-hr rainfall, P <sub>2</sub> .....	in.	4.80		
5. Land Slope, s .....	ft. / ft.	0.00340		
6. T <sub>t</sub> = $\frac{0.007 (nL)^{0.8}}{(P_2^{0.5} s^{0.4})}$ .....	hr	0.652	+	0.000 = 0.652 hrs.
				= 39.13 minutes

#### Shallow concentrated flow

	Segment ID	B	n/a	
7. Surface description (paved or unpaved) .....		Unpaved		
8. Flow length, L .....	ft.	2,434.1		
9. Watercourse slope, s .....	ft. / ft.	0.00541		
10. Average velocity, V (figure 3-1) .....	ft. / s	1.187		
11. T <sub>t</sub> = $\frac{L}{3600 V}$ .....	hr	0.570	+	0.000 = 0.570 hrs.
				= 34.19 minutes

#### Channel flow

	Segment ID	C	n/a	
12. Cross sectional flow area, a .....	ft <sup>2</sup>	230.1		
13. Wetted perimeter, P <sub>w</sub> .....	ft.	55.9		
14. Hydraulic radius, r = $\frac{a}{P_w}$ .....	ft.	4.1		
15. Channel slope, s .....	ft. / ft.	0.00085		
16. Manning's roughness coeff., n .....		0.035		
17. V = $\frac{1.49 r^{2/3} s^{1/2}}{n}$ .....	ft. / s.	3.190		
18. Flow length, L .....	ft.	3,122.7		
19. T <sub>t</sub> = $\frac{L}{3600 V}$ .....	hr	0.272	+	0.000 = 0.272 hrs
				= 16.32 minutes
20. Watershed or subarea T <sub>c</sub> or T <sub>t</sub> (add T <sub>t</sub> in steps 6, 11, and 19) .....		1.494		hrs
		89.64		minutes
Value used for Analysis (Minimum T <sub>c</sub> 0.10 hours) .....		1.49		hrs

Reference: 210-VI-TR-55, Second Ed., June 1986

**Appendix B**

**Shoreline Protection Information Flyer**



# False River Watershed Council

## How to Protect

&

## Restore

## a Natural Shoreline

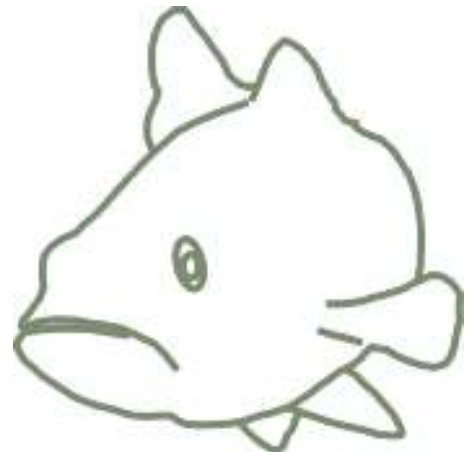
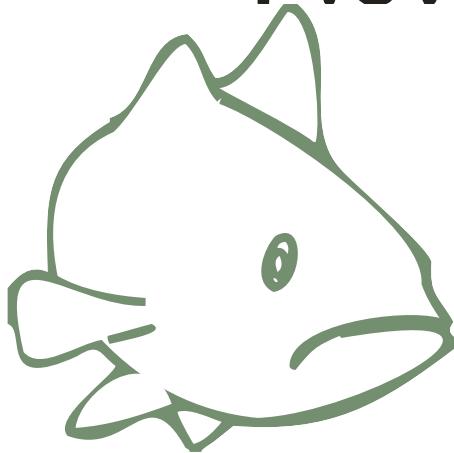

The False River Ecosystem Restoration Project seeks to foster property owners and tenants involvement to improve the water quality and fisheries of the lake. During Fall 2016 and Winter 2016-2017 the lake level will be temporarily reduced by **up to 6 feet**. During this period near shore sediments will be exposed to various degrees along the lakeshore. The drawdowns will allow property owners and tenants to take care of shoreline maintenance.

*The two most destructive actions along a shoreline to the lake ecosystem are:*

*Native vegetation removal & Hardening of the shoreline*

False River, like any lake, is subject to shoreline erosion from wind-driven waves and wake resulting from recreational motor boating. Property owners look for ways to control shoreline erosion when it becomes a problem. The most common hard structures on False River are bulkheads (shore anchored, vertical barriers) and seawalls (stronger cast-in-place concrete, stone or timber high-energy structures). These hard structures can often cause shorelines to be less stable than those protected by natural landscaping, because they do not allow for absorption of the energy that waves bring in. Waves hit the hard structures, and the energy is deflected (Fig. 1). This energy then (1) scours the lake bottom and causes erosion at the base of the wall resulting in increased turbidity of the water, and (2) is deflected to neighboring property causing further erosion.

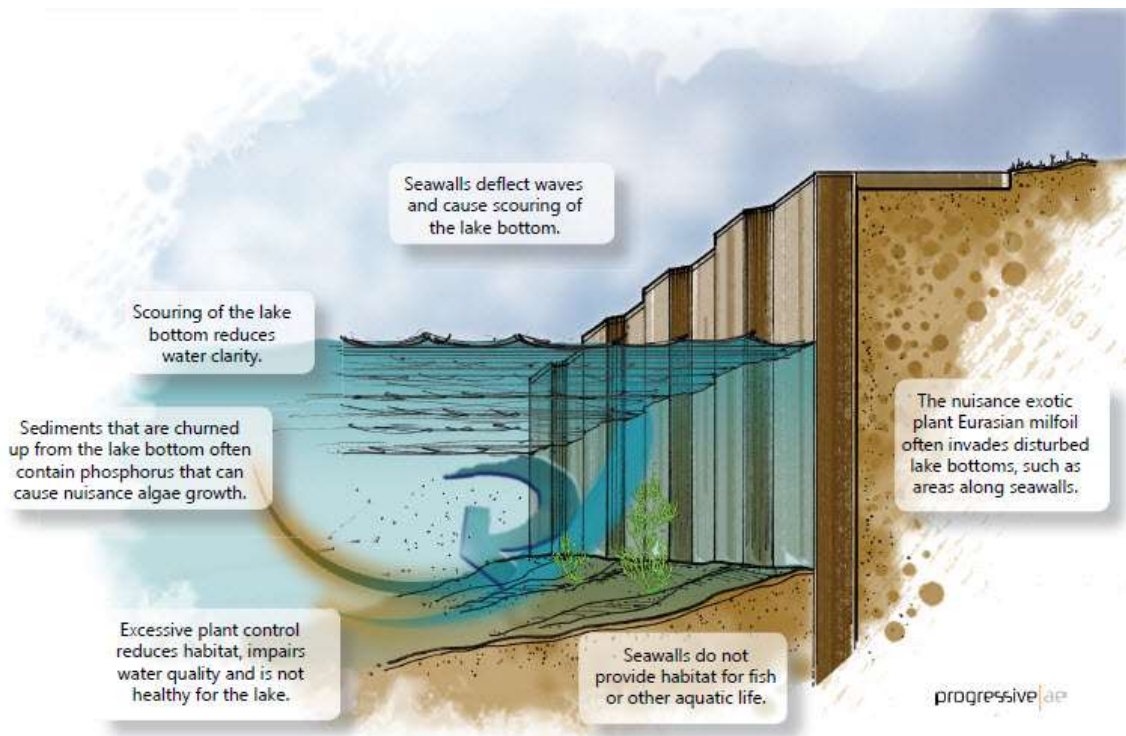

Figure 1: Hardened Shorelines  
(Source: progressiveae.com)

**Natural shorelines** (Fig. 2) help to sustain near-shore habitat essential to fisheries. In addition to critical habitat, natural shorelines create a buffer providing numerous water quality benefits, such as filtering stormwater. **Restoring a Natural Waterfront** on False River provides an essential element to restore an aesthetic character to the lake's waterfront using natural shoreline plants (e.g. Baldcypress, shoreline emergent grasses, etc.) and to decrease erosion by attenuating wave deflection.

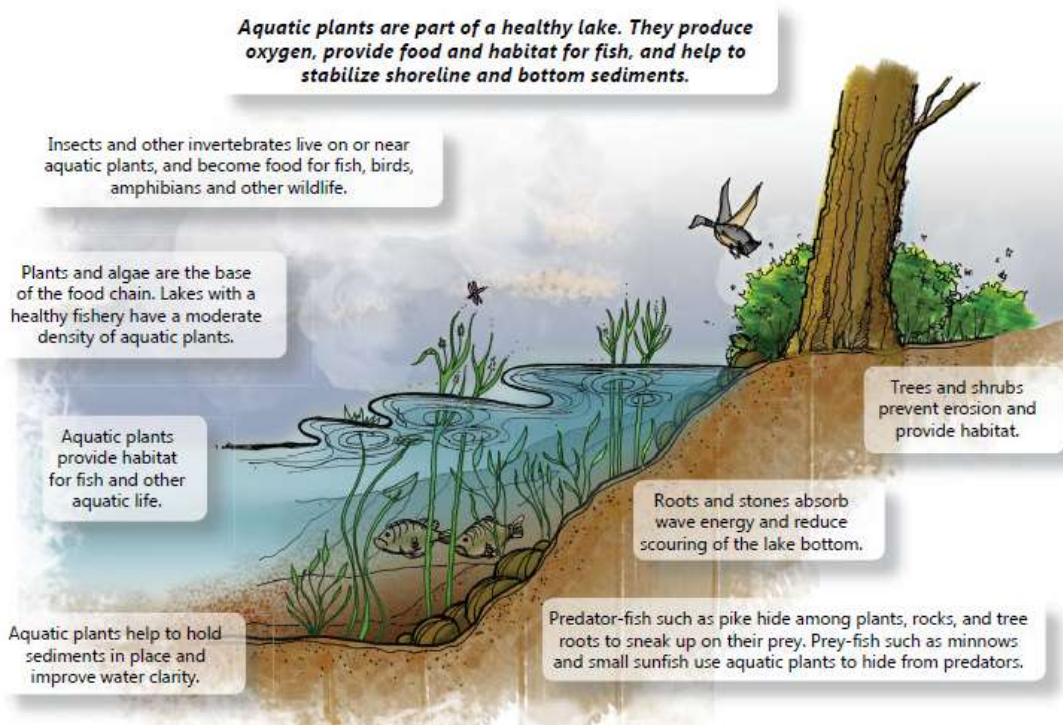
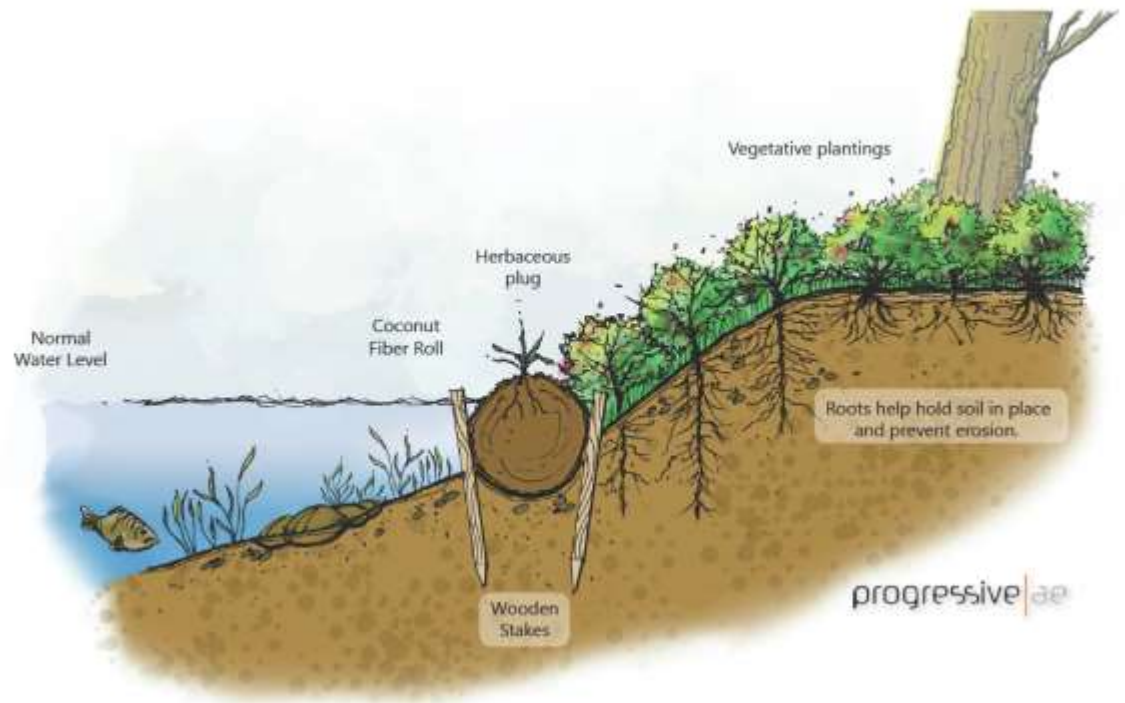

Figure 2: Natural Shoreline  
(Source: progressiveae.com)

**Bioengineered Shorelines** (Fig. 3) incorporate some of the aesthetic aspects of natural shoreline while providing for additional wave protection. This is the type of shoreline protection that was placed along the west side of the lake's South Flat island using Delta Land Services, LLC SHORE | LINKS® system .

Figure 3:  
Bioengineered  
Shoreline (Source:  
progressiveae.com)



For shoreline where excessive erosion is observed, and natural and bioengineered shoreline may not be adequate, the placement of a **rock revetment** (Fig. 4) may be an appropriate alternative. Although not aesthetically as pleasing as a natural shoreline, it does provide erosion control without causing excessive wave deflection.

Figure 4: Rock  
Revetment  
(Source: USDA-  
NRCS)

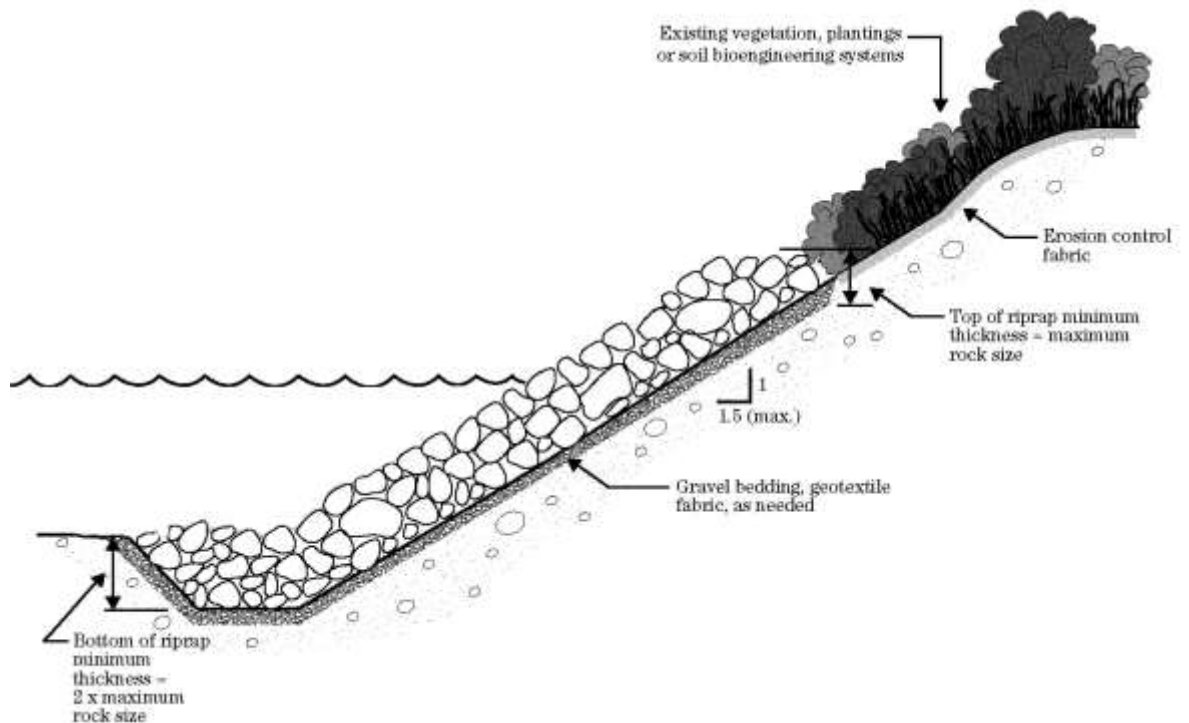

## Modifying Pre-Existing Hard Structures along a Shoreline

An inexpensive manner to modify existing hard structures to attenuate the negative effect of wave deflection from a pre-existing bulkhead or seawall can be achieved by placing rock or rip rap (>6" diameter) in front of the wall. This will decrease scouring, attenuate wave deflection and result in better water quality.

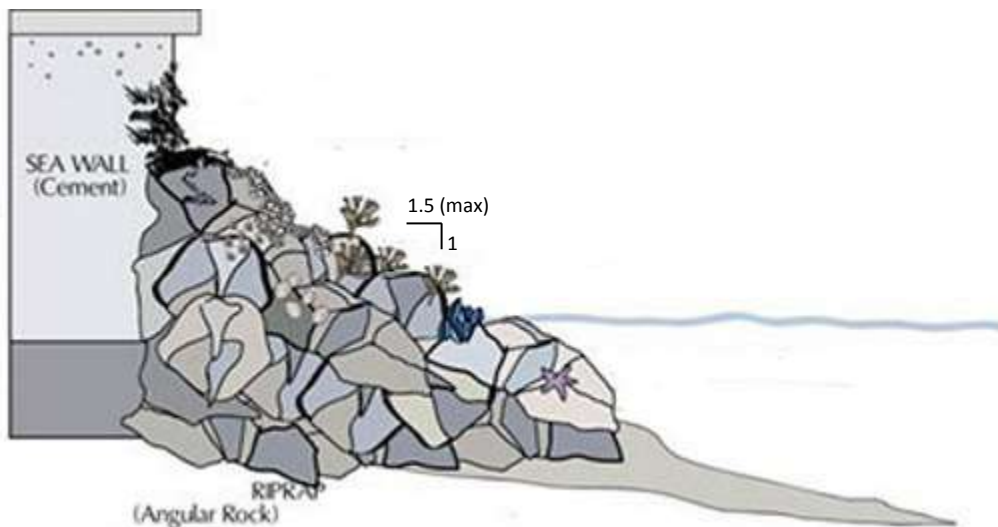

Figure 5: Modified Seawall  
(Source: Archipelago Marine Research Ltd.)

Another inexpensive shoreline modification commonly used to attenuate incoming waves energy is the installation 10-15 yards in front of hard structures or natural shoreline of a **Debris Fence** (Fig. 6).

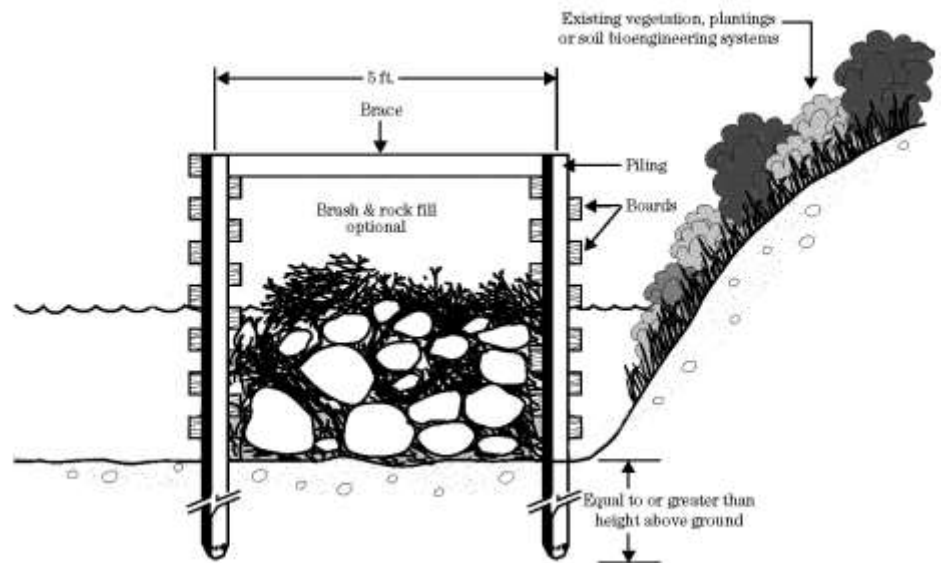

Figure 6: Debris Fence (or Christmas Tree Fence)  
(Source: USDA-NRCS)

### Suggested Resources:

NRCS' Engineering Field Handbook Chapter 16: Streambank and Shoreline Protection

(<http://directives.sc.gov.usda.gov/OpenNonWebContent.aspx?content=17553.wba>)

USEPA's Healthy Lakes & Higher Property Values ([https://www.epa.gov/sites/production/files/2015-10/documents/healthy\\_lakes\\_and\\_higher\\_property\\_values.pdf](https://www.epa.gov/sites/production/files/2015-10/documents/healthy_lakes_and_higher_property_values.pdf))

US Army Corps of Engineers' Design of Coastal Revetments, Seawalls, and Bulkhead.

[http://www.publications.usace.army.mil/Portals/76/Publications/EngineerManuals/EM\\_1110-2-1614.pdf?ver=2014-05-09-134451-777](http://www.publications.usace.army.mil/Portals/76/Publications/EngineerManuals/EM_1110-2-1614.pdf?ver=2014-05-09-134451-777)

This public document was published at a total cost of \$80.00. Five hundred (500) copies of this public document were published in this first printing at a cost of \$80.00. The total cost of all printings of this document, including reprints is \$80.00. This document was published in-house by the Louisiana Department of Natural Resources to disseminate information regarding Act 955 of 2010 to the general public under a special exception by division of administration (DOA). This material was printed in accordance with the standards for printing by state agencies established pursuant to R.S. 43:31.

**Appendix C**  
**Shoreline Ordinance**

# Pointe Coupee Parish Police Jury

## AN ORDINANCE

To amend Article III of Chapter 6 of the code of ordinances of the Parish of Pointe Coupee, Louisiana, to regulate the construction of retaining walls and other erosion prevention structures along False River; to require permits in connection therewith, and to further provide with respect thereto.

WHEREAS, LSA-R.S. 33:1236.25 authorizes the Pointe Coupee Parish Police Jury to adopt ordinances relative to the regulation of the construction of buildings and other structures over False River.

THEREFORE, BE IT ORDAINED by the Police Jury of the Parish of Pointe Coupee, Louisiana:

**Section 1.** Article III of Chapter 6 of the code of ordinances of the Parish of Pointe Coupee, Louisiana, is hereby amended and re-ordained so as to read as follows:

### “Article III. FALSE RIVER REGULATIONS

#### Section 6-25. Purpose.

The purpose of this article is to promote the health, safety and general welfare by regulating the situation of structures over False River so as to preserve the beauty and safe and equitable enjoyment of said lake for those who are entitled thereto.

The provisions of this ordinance are designed to:

- Protect a vital natural resource for current residents and future generations by improving the water quality and restoring the biological habitat and natural ecosystem of False River
- Enable property owners along False River to more effectively protect their property, property values, and capital investments
- Encourage responsible economic growth and investment in the Parish, while protecting the taxpayers of Pointe Coupee Parish from costs or liabilities associated with the active management of False River water levels

The provisions of this ordinance and any rules and regulations adopted pursuant hereto shall be applicable, and shall govern the waters of False River within the legal shoreline and public and private properties adjacent thereto.

#### Section 6-26. Definitions.

The following definitions are presented to clarify the meaning of terms as they apply to specific sections of this article. Unless specifically defined below, words or phrases shall be interpreted to give them the meaning they have in common usage and to give these regulations the most reasonable application. Words in the present tense shall include the future; the singular number shall include the plural and the plural the singular; and the word "shall" is mandatory and not discretionary.

*Boathouse.* A structure which houses a boat, raft, party barge or other watercraft.

*Boat ramp.* A structure, whether owned by a public body or a private person, which is intended to facilitate the launch of a watercraft into a waterway.

*Boundary line.* A straight line commencing at a point on the legal shoreline at which the boundary between two (2) parcels of land intersects said legal shoreline and extending in a perpendicular direction into False River.

*Bulkhead.* Retaining walls whose primary purpose is to hold or prevent the backfill from sliding, eroding, or otherwise falling into False River, while providing protection against light-to-moderate wave action. Retaining walls may also be used for reclamation projects where fill is

needed beyond the existing shore, and for marinas and other structures where deep water is needed directly at the shore. For the purposes of this ordinance, seawalls or any other manmade vertical structures (concrete, steel, aluminum, wood, composite, etc.) shall be classified as bulkheads. For other erosion prevention structures, see 'Revetments' below.

*Bulkhead Permit.* Prior written approval by the Pointe Coupee Parish governing body for the construction of any structure (including revetments) or the deposition of any material or any other action described herein requiring a permit at the water's edge of False River.

*Clearing.* Any activity that removes the trees, shrubs, or vegetative ground cover.

*Encroachment.* Any work which is placed upon or maintained beyond the legal shoreline into and over the public side of False River.

*Governing Body of Pointe Coupee.* Either the Pointe Coupee Parish Police Jury or, after January 19, 2019, the Pointe Coupee Parish Council and Parish President (hereafter referred to as "the PARISH").

*Hazardous Substances.* Materials deemed to be dangerous to the health, safety, or general welfare of the public as defined by the Louisiana Water Control Law (RS 20:2017-2078), the Federal Water Pollution Control Act (P.L. 92-500, as amended) and the Federal Water Quality Standards (48 FR 51405).

*Legal Shoreline of False River.* The line which separates public from private ownership along False River, as defined by LRS 9:1110, commonly known as its bank.

*Material.* Rock, gravel, sand, shell, silt, dirt, concrete, metal or other inorganic substances used to fill any portion of False River.

*Perpendicular.* Standing at right angles to the bank or legal shoreline of False River.

*Person.* Any individual, partnership, corporation, limited liability company, limited liability partnership, organization, municipality, governmental entity, or other entity.

*Pier.* A structure extending any length into False River from the shore or bank, built upon pilings or floatation devices with water on both sides, with or without a sunshade or boathouse.

*Private side.* The side of the legal shoreline owned by a private person.

*Public side.* The side of the legal shoreline owned by the State of Louisiana as defined by LRS 9:1110.

*Revetment.* A sloped facing of erosion resistant material, such as stone, rip-rap, or concrete, that is built to protect a scarp, embankment, or other shoreline feature against erosion. The major components of a revetment are the armor layer, filter, and toe. The armor layer provides the basic protection against wave action, while the filter layer supports the armor, provides for the passage of water through the structure, and prevents the underlying soil from being washed through the armor. Toe protection prevents displacement of the lakeward edge of the revetment.

*Sewerage system.* A system capable of handling sewerage which is approved by the Pointe Coupee Parish Health authorities.

*Situated.* To construct, build or otherwise place.

*Stage, Normal Pool.* The level at which the water is maintained in False River; sixteen (16) feet above mean sea level.

*Stage, Flood.* The level above which boat ramps providing access to the lake are closed to the public; eighteen (18) feet above mean sea level

*Turbidity Mitigation Structure.* A structure used to improve water clarity by diminishing the amount of silt and/or sediment in bodies of water. These structures are designed to provide scour protection and/or energy dissipation along the shoreline to minimize lakebed or shoreline disturbances caused by wave action.

*Water's edge.* The point at which the waters of False River meet the shoreline at the Normal Pool Stage.

*Wharf.* A structure built upon pilings or floatation devices along the shore or bank and generally connected with the bank or shore along its length, with or without a sunshade or boathouse.

*Work.* Any construction, building or placement of structures or materials of any kind along the legal shoreline of False River, excluding mere repairs to but not replacements of existing structures that have been previously permitted.

Section 6-27. Piers, wharves, boathouses, boat ramps, bulkheads or other works

- A. No person shall construct or otherwise cause to be situated on the public side of the legal shoreline of False River, either in whole or in part, any pier, wharf, boathouse, bulkhead or other work unless same be situated so that no portion thereof shall extend across a boundary line. No boathouse shall be situated unless there is suitable space for the entry and exit of the watercraft which it houses without having to cross a boundary line.
- B. No person may operate a boat ramp while Pointe Coupee Parish is under a Parish declared state of emergency, when the lake level exceeds 18 feet and shall remain until the level falls below 17.5 feet, or any other time period for which the Parish Government has declared that the operation of a boat ramp poses a risk or hazard to persons or property, without the consent of the Parish Government. During a declared state of emergency, the authority of the Parish Government set forth herein may be exercised by the President thereof. Nothing herein shall prohibit the operation of a boat ramp to save or protect life or property, when in imminent danger. The lake level for purposes of this ordinance shall be declared by the designee of the President.
- C. No person shall construct or otherwise cause any bulkhead or permanent erosion control structure to be situated on the public side of the legal shoreline. Any appurtenance structure used in conjunction with a bulkhead for turbidity mitigation may extend beyond the legal shoreline if, and only if: 1) the structure is not constructed of permeant materials, 2) the structure does not exceed an elevation higher than one (1) foot above the normal pool stage of False River, 3) the portion of the structure above water level does not exceed 1.5 feet beyond the legal shoreline, 4) the slope of the portion of the structure below the water level is not less than 1.5 vertical feet for every 1.0 horizontal foot, and 5) no portion of the structure shall extend across a boundary line. Furthermore, structures extending beyond the legal shoreline may be subject to additional state and/or federal regulations or permitting requirements.
- D. No hazardous substances shall be employed in the construction or placement of piers, wharves, boathouses, or bulkheads, and sewerage systems shall be required where sewerage waste is collected. All materials placed into False River shall meet the requirements of the Louisiana Water Control Law (RS 20:2017-2078), and be in conformity with the Federal Water Pollution Control Act (P.L. 92-500, as amended) and the Federal Water Quality Standards (48 FR 51405).
- E. No structure including, but not limited to, any artificial obstruction, temporary or permanent, nor any bulkhead, rip-rap, seawall or other erosion prevention or land reclamation project or other material used for such purposes shall be situated, reconstructed, removed or repaired by any person along the legal shoreline, or along the water's edge if within the private side of the legal shoreline, of False River without first securing a Bulkhead Permit from the Parish. A Permit Application must be submitted for all work along the above described area, regardless of any other federal, state or local permits required by other agencies. A permit issued by the Parish does not relieve the applicant from any other permit requirements from any other federal, state, or local agency.
- F. Bulkhead Permits. Every permit application shall be accompanied by a set of plans and specifications which clearly and accurately describe the project. All bulkheads shall be designed/engineered by a Louisiana Licensed Engineer in which all civil, structural, and geotechnical issues have been analyzed pursuant to accepted engineering standards and practices to ensure a service life of the bulkhead consistent with that which has been communicated to the property owner. For bulkhead installations, construction drawings and calculations bearing the stamp of the engineer, the contractor's Louisiana License number, and projected service life shall accompany each application for a bulkhead permit. Additionally, a certificate of insurance, issued by the engineer's insurer, shall list the land owner/home owner and



shall be provided at time of permit application. Any and all costs for preparing said plans and specification shall be borne by the person requesting the permit. There shall be a fee of \$250 charged for the processing of the permit application. Permit application instructions and permit application forms, as revised and adopted by the governing body in connection with this ordinance are attached hereto as "Appendix A."

- G. Bulkheads constructed, or under construction prior to the effective date of the Bulkhead Permit requirement shall be considered legally nonconforming. Bulkheads which have been abandoned, are considered unsafe, or are illegally located on public property shall immediately be removed or repaired by the owner and brought into conformance with this article. Any repairs or alterations to legally nonconforming bulkheads must be brought into conformance with this article through the Bulkhead Permit application process. All nonconforming bulkheads must be brought into conformance or removed by December 31, 2027.

#### Section 6-28. Enforcement.

Whenever a violation of any provision of this article occurs, or is alleged to have occurred, any property owner or citizen of this state may seek redress, including, but not limited to, injunctive relief, through the District Court of Pointe Coupee Parish.

Any resident of the community who believes that a violation of any of the provisions of these regulations is occurring may file a written complaint with the Parish. Such complaint shall fully set forth the acts or omissions constituting the alleged violation and the site or sites at which such violation or violations are alleged to be occurring. The Parish shall record properly such complaint, promptly investigate the allegations underlying said complaint, and take action on such complaints as provided by these regulations.

Whenever the Parish, on the basis of a written complaint, has reason to believe that a violation of these regulations may exist, the Parish may require any person owning the structure or land, within thirty (30) days of notification to produce information as may be necessary, in the judgment of the Parish, to determine the existence or extent of any violation.

Penalty - Any person violating any provision of these regulations shall have a period of ninety (90) days after the exhaustion of all appeals to correct the violation. Failure to comply with this ordinance after the ninety (90) day period shall constitute a misdemeanor, and upon conviction shall be punished for each separate offense by a fine not exceeding five hundred dollars (\$500.00) or imprisonment for a term not exceeding thirty (30) days, or both, and in addition shall pay all costs and expenses involved in the case. Each day any violation of any provision of these regulations shall continue shall constitute a separate offense.

Any architect, engineer, builder, contractor, agent or other person who commits, participates in, assists in, or maintains such violation may each be found guilty of a separate offense and suffer the penalties herein provided.

Appendix A. False River Bulkhead Permit Processing Instructions, False River Bulkhead Permit Application, and Private Property/State Property Letter of Agreement"

**Section 2.** If any section, part, paragraph, sentence or clause of this ordinance should be declared invalid or unenforceable, such invalidity or defect shall not affect the remaining sections, paragraphs, parts, sentences, or clauses hereof and, to this end, the several provisions hereof are declared to be severable.

**Section 3.** All ordinances or parts thereof in conflict herewith are hereby repealed.

**Section 4.** The provisions of this ordinance shall become effective immediately upon signature of the President, after adoption by the Police Jury and approval thereof by the Louisiana Department of Natural Resources.

# **APPENDIX A, Article III – Pointe Coupee Parish Code of Ordinances – False River Regulations**

## **Pointe Coupee Parish Police Jury**

**160 E. Main St, New Roads, Louisiana 70760**

Telephone (985) 447-7155 Facsimile (985) 447-6307

### **False River Bulkhead Permit Processing Instructions**

**Pointe Coupee Parish, Louisiana**

This packet contains information related to obtaining a permit to construct a bulkhead, shoreline modification, and/or dredge or filling in a portion of False River in Pointe Coupee Parish, LA as required by Chapter 6, Article 3 (False River) of the Pointe Coupee Parish Ordinances. In addition to the permit issued by the governing body of Pointe Coupee Parish (the “PARISH”) through this application process, other permits, certifications and/or approvals from other state or federal agencies may be required for the activity you are undertaking. Those agencies may include, but may not be limited to:

U.S. Army Corps of Engineers, New Orleans Division  
Operations & Readiness Div., Regulatory Functions  
P.O. Box 60267,  
New Orleans, Louisiana 70160-0267  
(504) 862-1270

LA Department. of Environmental Quality  
Office of Water Resources  
PO Box 82215  
Baton Rouge, LA 70884-2215  
(504) 765-0664

LA Department of Wildlife & Fisheries  
PO Box 98000  
Baton Rouge, LA 70898

LA Division of State Lands  
PO Box 44124  
Baton Rouge, LA 70804

LA Department of Health and Hospitals  
Office of Public Health  
PO Box 60630  
New Orleans, LA 70160

**IF YOU ARE PROPOSING TO DREDGE OR FILL ANY PORTION OF FALSE RIVER, IN ADDITION TO THE PARISH’S PERMIT, YOU MAY NEED TO SECURE PERMITS FROM THE U.S. ARMY CORPS OF ENGINEERS AND/OR OTHER FEDERAL, STATE AND LOCAL GOVERNING ENTITIES, INCLUDING BUT NOT LIMITED TO THE CITY OF NEW ROADS IF YOUR PROPERTY IS WITHIN CITY LIMITS. IT IS HIGHLY RECOMMENDED THAT YOU CONTACT THESE AGENCIES PRIOR TO THE ONSET OF ANY ACTIVITY IN, OR AT THE WATER’S EDGE OF FALSE RIVER.**

This instruction packet contains information needed to properly complete the Bulkhead Permit Application for submission to THE PARISH. Included in this packet are activities regulated under this permitting process, associated fees, timelines for issuing permits, and operational procedures of the application process, including instructions for completing the actual application. **IT IS HIGHLY RECOMMENDED THAT YOU READ THESE INSTRUCTIONS, ALL SUPPLEMENTARY MATERIALS, AND THE FALSE RIVER REGULATIONS IN THEIR ENTIRETY PRIOR TO BEGINNING A PROJECT.** *Depending on the scope of your project, this permit may not be required. Therefore, if you have any questions about your proposed activity, please contact the PARISH at (225) 638-9556 for additional guidance.*

## **THE APPLICATION FORM**

(Please use black ink when completing this application)

In addition to the actual permit application, the following supplementary materials must be submitted with the actual application for the application to be considered complete:

- 1) One set of original drawings or good reproducible copies which show the location and character of the proposed activity (see 'DRAWINGS' section below)
  - a. Depending on the scope of the project, applications may also require plans that are certified and stamped by a Professional Engineer currently licensed in the Louisiana. For more information, please review the 'GENERAL CONSTRUCTION LIMITS' below.
- 2) A certified copy (by the Parish Clerk of Court) of the Act evidencing ownership of the Property (e.g., Act of Sale, Donation Judgment of Possession, etc.), including the property's legal description.
- 3) If the applicant is not the legal property owner, a letter signed by the property owner expressly authorizing the applicant to file an application on behalf of the property owner

Any application that is incomplete, or prepared incorrectly or illegibly will not be processed until completed and/or corrected.

**ITEM 1.** Leave Blank. A permit number will be assigned to the application by the PARISH upon receipt. The applicant/agent will be notified of receipt of the application.

**ITEM 2.** Type or print the name and address as well as home and office phone numbers of the person who is proposing the activity requiring a permit. This is usually the owner or occupant of the property upon which the proposed activity will be constructed.

**ITEMS 3 & 3a.** Type or print the name, title and address of the person you have authorized to act on the applicant's behalf in the procedural and informational negotiations required by this application. The applicant is not required to, nor is it recommended that the applicant authorize someone to act in the applicant's behalf for this application. However, it is important that the applicant understands that the PARISH views negotiations with an authorized agent as negotiations with the applicant. The applicant shall be bound by the permit negotiated with an

authorized agent, unless the PARISH is provided written notice of removal of the agent from authorization to negotiate on the applicant's behalf, prior to issuance of the permit.

**ITEM 4.** Type or print a detailed, but short description of the proposed activity for which a permit is being requested. Additional pages may be used if the space provided is not adequate.

**ITEM 4a.** Type or print information on the purpose and intended use of the proposed activity. The PARISH must evaluate the impacts of the activity on False River, including, but not limited to, the environment, its water quality, navigation, and hydrologic flow.

**ITEM 4b.** If the activity includes the dredging or filling of any portion of False River, no matter how slight or incidental, the number of cubic yards dredged or filled must be calculated and entered in this ITEM. In addition, all imported fill material must be free of any hazardous material and must be free of any contaminant outlined in the Clean Water Act. A permit from the US Army Corps of Engineers as well as certification from the Louisiana Department of Environmental Quality (and possibly other agencies) are required if any dredging of False River occurs because of this activity. These permits and certifications are in addition to the one issued by the PARISH. **IT IS HIGHLY RECOMMENDED THAT YOU CONTACT THESE AGENCIES IF THE PROPOSED ACTIVITY INCLUDES DREDGING OR FILLING OF FALSE RIVER.** The volume of material of dredged or hauled-in materials is calculated by the following formula:

**Length of dredge area (or area to be filled) X Width of dredge area (or area to be filled) X Depth of dredging (or area to be filled) divided by 27 (=) equals \_\_\_\_\_ cubic yards of material. (all measurements must be in feet)**

**ITEM 5.** Insert the names and addresses of the adjacent property owners along False River (both sides) upon which the proposed activity is located. This information is needed for their possible notification of the intended proposed activity. Comments may be solicited from each property owner prior to the issuance of a permit.

**ITEM 6.** Insert the physical address of the property upon which the proposed activity will occur. If a visible street address is not available, please insert directions as to the location of the property for inspection purposes.

**ITEM 7.** Place an "x" in the appropriate location. If any of the proposed activity already exists or if construction has already begun on the proposed activity, mark "yes" and explain the reason for beginning construction prior to the issuance of a permit by the PARISH. Be sure to insert the month and year in which the construction began. Designate all existing construction in the drawings attached to this permit.

**ITEM 8.** If other permits are necessary or have been applied for or secured, insert the name of the agency from which a permit was requested, as well as the type of approval needed, the identification number of the permit request, and the dates of application, approval and/or denial. This information must be supplied for each agency and permit required.

**ITEM 9.** Sign and date the application. If an agent has been authorized to act in behalf of the applicant, the agent's signature and date of signature is also required.

**ITEM 10.** Private Property / State Property Letter of Agreement. This Agreement Letter must be signed and notarized before any permit application will be approved by the PARISH.

## **DRAWINGS**

Clear and accurate drawings are necessary for the Parish to process your application. Because the description of proposed work on the application is brief, drawings are the primary means of determining the impact(s) of your work and evaluating whether a permit should be issued or denied. Inadequate or inaccurate drawings will result in a processing delay or rejection of your permit application

Minimum Drawing Requirements: Need clear vicinity map, plan view and elevation or cross-section drawings. on sheets of paper no smaller than 8.5 x 11 inches, and no larger than 11 x 17 inches. Examples can be obtained from the PARISH. All drawings **MUST**:

- 1) Be reproducible **black or blue ink only**: **DO NOT USE COLORS as it will not copy.**
- 2) Be on sheets of paper no smaller than 8.5” x 11”, and no larger than 11” x 17”
- 3) Include dimensions, distances and scales
- 4) Clearly define the limits of any dredging on plan view and dimensions of spoil placement, if applicable
- 5) Include normal pool stage and the references to the legal shoreline on plan view and elevations (maps may be obtained from the PARISH)
- 6) Include North arrow on plans view
- 7) Include turbidity mitigation structure
- 8) Identify previously completed work as “existing” and requested work as “proposed.”
- 9) Show existing ground contours, shorelines (at normal pool stage) and proposed work

Performing work not shown on the drawings or indications of incorrect conditions at the worksite may result in suspension or revocation of permits, and/or legal action against the violators. In addition to a final field inspection, the PARISH may perform preliminary inspections during the construction phase of the project to ensure that the conditions of the worksite are consistent with the submitted drawings. If, upon final inspection, the PARISH determines that the conditions of the project are inconsistent with the submitted drawings, the PARISH may

- suspend or revoke of the permit,
- require the landowner to comply with the submitted drawings (at the landowner’s expense),
- require landowner to return the worksite to the pre-application conditions, and/or
- proceed with legal action against the landowner

Most applications for permits include drawings that are prepared by engineering or land

surveying firms. However, for some projects (see ‘General Construction Limits’ section below), applicants may prepare their own drawings if they are capable of preparing adequately scaled drawings and taking field measurements and soundings to obtain the necessary data. Applicants should insure that the drawings fully and accurately describe the proposed activity and the conditions at the worksite.

Drawings submitted with a permit application are property of the PARISH, and may be reproduced or distributed as necessary. As part of the permit review process, the PARISH may mail copies of the submitted drawings to adjacent property owners listed on the application to solicit comments, suggestions or objections on the proposed activity.

Sample drawings, or drawings of prior permitted projects are available from the PARISH, and can be furnished upon request. Sample drawings furnished by the PARISH are illustrative only, and are not intended to be representative of the exact conditions of your site. If field inspections of the work authorized by your permit show conditions significantly different than what is shown on your drawings, it could cause legal action to be taken and/or your permit to be revoked.

## **GENERAL CONSTRUCTION LIMITS**

**BULKHEADS** - Permits for the construction of bulkheads may be granted under this permit process. Bulkheads will be considered for a permit by the PARISH only if the following conditions are met:

- 1) The plans and calculations are certified by a Professional Engineer currently licensed in the State of Louisiana. The stamp of the engineer shall be placed on all plans and calculations to ensure that all civil, structural, and geotechnical issues have been analyzed pursuant to accepted engineering standards and practices. In addition to the engineer’s stamp, construction drawings shall include, the contractor’s Louisiana License number and projected service life of the bulkhead. Applicants shall also attach a certificate of insurance, issued by the engineer’s insurer, listing the landowner/homeowner as additionally insured parties.
- 2) There will be no permanent encroachment on the public side of the legal shoreline of False River; as defined in Chapter 6, Article III, Section 6.26 (False River Regulations: Definitions)
- 3) The bulkhead is designed to maintain structural integrity regardless of the presence, absence, or level of water on the lakeward face, as False River lake water levels may vary significantly due to natural causes (e.g. drought or flood) or active lake water level management practices, such as ‘drawdowns.’
- 4) The bulkhead is designed to protect against erosion/scouring where the lakeward facing intersects the lake bottom caused wave action.
- 5) The bulkhead is designed to minimize turbidity, or incorporates a turbidity mitigation structure on the lakeward facing with an elevation of at least one (1) foot above the normal pool stage of False River
- 6) Any appurtenance structure used in conjunction with a bulkhead for turbidity mitigation

may extend beyond the legal shoreline if, and only if:

- a. the structure is not constructed of permeant materials,
- b. the structure does not exceed an elevation of two (2) feet above the normal pool stage of False River,
- c. the portion of the structure above water level does not exceed three (3) feet beyond the legal shoreline,
- d. the slope of the portion of the structure below the water level is not less than 1.5 vertical feet for every 1.0 horizontal foot, and
- e. no portion of the structure shall extend across a boundary line. Furthermore, structures extending beyond the legal shoreline may be subject to additional state and/or federal regulations or permitting requirements

REVTMENTS – Permits for revetments or similar erosion control structures may be granted under this process. Due to the variability in these types of structures, the need for certified plans (Item #1 above) will be evaluated on a case by case basis. However, the general guidelines for bulkheads will also be applicable for erosion control structures.

### **GENERAL PERMIT CONDITIONS**

The following conditions will apply to all permits issued by the PARISH. It is incumbent that applicants read and understand all these conditions (along with any special conditions) before applying. Special conditions (exceptions to the rule) will be applied on a case by case basis upon written request of the applicant and upon approval of the PARISH Governing Body during open session of a regular meeting.

If any previously unknown historic or archeological remains are discovered, the activity authorized under the Permit must cease until proper local, state or federal coordination is made to determine if the remains warrant recovery effort.

Permittee must maintain the activity and/or structure authorized by this permit in good condition and in conformance with the terms and conditions of this permit and with any other permits issued in connection with the permitted activity or structure. Should Permittee wish to cease to maintain the authorized activity or structure, Permittee must notify the PARISH in writing, and if requested to do so by the PARISH, remove the structure at Permittee's sole expense.

Permittee must allow representatives from the PARISH to inspect the authorized activity or structure at any time prior to, during, and upon completion of construction to ensure that the project execution is consistent with the terms and conditions of the permit.

By issuing this Permit, the PARISH assumes no responsibility for the design, engineering, and/or construction sufficiency of the proposed structure/work described by Permittee in the application for a permit. For projects that include non-permanent encroachment onto the public side of the legal shoreline (see "General Construction Limits"), Permittee recognizes that if at any time in the future, the PARISH or any local, state, or federal authority with jurisdiction over the permitted structure determines that the proposed structure/work must be removed to

accommodate a local, state, or federal project, or any other reasonable basis, the PARISH may require Permittee to remove the structure at Permittee's sole expense.

The PARISH will not be liable for any damage to the proposed structure or activity due to collisions with marine traffic or water level management practices. Further, should any governmental authority with jurisdiction determine that the permitted structure or activity poses a navigation hazard, the PARISH may require Permittee to remove the structure or activity at Permittee's sole expense.

Should the PARISH require the Permittee to remove the permitted structure and restore the shoreline to its original condition, Permittee shall have thirty (30) days to comply with the PARISH's written notice to remove. Should Permittee fail to remove the structure and restore the shoreline to its original condition, the PARISH shall have the right to remove the structure and thereafter bill Permittee for any and all costs of same. Should Permittee fail to reimburse the PARISH for the costs of removal of the structure within forty-five (45) days of receipt of written invoice, Permittee shall also be liable for any expenses incurred by the PARISH, including legal fees, and any other costs expended to collect the amount due from Permittee.

Permittee, recognizes that any damage to the structure/work constructed pursuant to this permit, resulting from the activities of the PARISH, state, or federal government including, but not limited to, dredging and False River lake water level management are to be the sole responsibility of Permittee, and the PARISH assumes no liability therefore.

Permittee agrees to defend, indemnify and hold and save the PARISH, including members of its governing body, members of its advisory committees (e.g. False River Watershed Council), directors, officers, employees, representatives and attorneys, harmless from any claim, loss, costs, expense, liability, damage, or cause of action, including reasonable attorneys' fees, whatsoever, on account of injury to or death of persons or damage to or loss of property arising out of or relating to the structure or activity permitted, regardless of fault.

Limits of the PARISH's permit:

- 1) This permit does not obviate the need to obtain other local, state or federal permits required by law.
- 2) This permit does not grant any property rights or exclusive privileges.
- 3) This permit does not authorize any interference with the property rights of others.
- 4) This permit does not authorize interference with any existing or proposed local, state or federal project.

Limits of the PARISH's Liability. In issuing this permit, the PARISH does not assume any liability for the following:

- 1) Damages to the permitted project or uses thereof as a result of other permitted or unpermitted activities or from natural causes.
- 2) Damages to the permitted project or uses thereof for any reason, including, but not limited to, active False River lake water level management undertaken by or on behalf of the PARISH or any local, state, or federal governing agencies.



- 3) Design or construction deficiencies associated with the permitted work.
- 4) Damages associated with any future modification, suspension, or revocation of this permit.

# Pointe Coupee Parish Bulkhead Permit Application

Ordinance Number XX

The Pointe Coupee Parish Bulkhead permit program is authorized by Section XX of Ordinance No. XX enacted in XXXX by the governing body of Pointe Coupee Parish (the "PARISH"). The section of this Ordinance requires permits authorizing activities in or affecting waters of False River in Pointe Coupee Parish, LA. This permit covers construction of bulkheads, bank erosion prevention or land reclamation projects, seawalls, rip-rap placement, etc. Information in this application is made a matter of public record through the publishing of minutes in the official journal of the Parish. Disclosure of the information requested is voluntary, however, the data requested is necessary in order to communicate with the applicant and to evaluate the permit application. If necessary information is not provided, the permit application cannot be processed nor can a permit be issued. *If more space is required for any portion of this application, please include the responses as an attachment.*

One set of original drawings or good reproducible copies which show the location and character of the proposed activity must be attached to this application and submitted to the PARISH for approval prior to the beginning of any work. Any application that is not complete, prepared correctly or understandable will be returned for corrections or clarification. Prior to submitting this application, applicants should read the Bulkhead Permit Processing Instructions, which contains detailed application instructions, minimum drawing requirements, engineering/design requirements, and general permit conditions.

1. Application Number: (Assigned by the PARISH)

3. Name, Address, & Title of Authorized Agent:

2. Name and Address of Applicant:

Telephone Number of Applicant:

Telephone Number of Agent:

Home:

1)

Work:

2)

3a. Statement of Authorization:

I hereby designate and authorize \_\_\_\_\_ to act in my behalf as my agent in the processing of this permit application and to furnish, upon request, supplemental information in support of this application.

Signature of Applicant \_\_\_\_\_ Date \_\_\_\_\_

4. Detailed Description of proposed activity:

4a. Purpose	
4b. Discharge of dredged or fill material for proposed activity.	
5. Name, Address & Phone Number of adjoining property owners on both sides of proposed site.	
5a. Side A Property Owner:	5b. Side B Property Owner:
Name:	Name:
Address:	Address:
Telephone Number:	Telephone Number:
6. Physical location of proposed site*	
6a. Street Address: _____	
6b. City, Zip: _____	
6c. Descriptive location (location from prominent landmark):	
* Note that a certified copy of the Act conferring title to the above described property must be submitted with this application.	
7. Is any portion of the activity for which this permit is sought now complete?      ____ YES      ____ NO	
If YES give reasons including the year and month the activity was completed. Indicate the amount of completed project on accompanying drawings.	

8. List all Approvals, Letters of No Objections, Letters of Objections or Denials received from other federal, state or local agencies for the proposed activity. Indicate when other agency actions were sought. (use additional pages if necessary)

Agency	Date of Application	Type Approval/Disapproval	Permit Number
1			
2			
3			
4			
5			
6			
9. Certifications			

a) Application is hereby made for a permit to authorize the activities described herein. I certify that I am familiar with the information contained in the application, and the regulations for such activities contained in Ordinance No. XX, and that to the best of my knowledge, the information contained in the application is true, complete and accurate. I further certify that I possess the authority to undertake the proposed activity or I am acting as a duly authorized agent of the applicant.

b) I have been made aware of the State of Louisiana's property rights as it pertains to False River, and have acknowledged those rights with signing and notarizing the attached Private Property / State Property Letter of Agreement.

c) I have also been made aware of and understand that should the permitted activity or structure interfere with the operations of the PARISH or any federal, state or local project, I will have to remove the structure, restore the bank to its original condition and/or cease the permitted activity at my sole expense.

d) Issuance of this permit does not confirm any ownership rights to water bottoms.

\_\_\_\_\_  
Signature of Applicant

\_\_\_\_\_  
Date

\_\_\_\_\_  
Signature of Agent

\_\_\_\_\_  
Date

# Private Property / State Property Letter of Agreement

I, \_\_\_\_\_, have applied for a False River Bulkhead Permit for the below described project:

Project Description: \_\_\_\_\_

\_\_\_\_\_

Project Location : \_\_\_\_\_

\_\_\_\_\_

\_\_\_\_\_

\_\_\_\_\_ (initial) I understand and agree that the State of Louisiana has certain ownership rights to the banks of False River. Those rights are specifically defined by LRS 9:1110

\_\_\_\_\_ (initial) I understand and agree that at anytime in the future, it is determined that the above project is located on state lands and said lands are needed for a local, state or federal project, that I as the owner will be responsible for the removal at my cost and expense of any improvements made to said property. If I refuse to timely remove the permitted structure or activity within thirty (30) days after receipt of written notice, the PARISH can cause same to be removed and thereafter recoup all costs and expenses, including attorneys fees, associated with such removal.

\_\_\_\_\_  
(signature)

\_\_\_\_\_  
(notary signature)

\_\_\_\_\_  
(printed signature)

\_\_\_\_\_  
(printed signature)

\_\_\_\_\_  
(address)

\_\_\_\_\_  
(notary ID or Bar Roll No.)

\_\_\_\_\_

\_\_\_\_\_

\_\_\_\_\_

## **Appendix D**

### **Water Quality Best Management Practices**

**Cropland Best Management Practices (1)- Sediment Concerns in Surface Water**

<b>Favorable BMPs (2)</b>	<b>Effectiveness of Favorable BMPs</b>	<b>Crops(3)</b>	<b>Practices Which May Be Unfavorable (4)</b>
<b>Mulch Till</b>	slight	1, 2, 4-6	Land clearing
<b>No Till</b>	moderate	1, 2, 4-6	
<b>Ridge Till</b>	slight-moderate	1,-3, 5, 6	Access roads
<b>Contour farming</b>	moderate	1,2,5,6	Clearing & snagging
<b>Grassed waterway</b>	slight-moderate	1-6	
<b>Residue Mgt., Seasonal</b>	slight	1-6	
<b>Grade stab strut.</b>	slight-moderate	1-6	
<b>Cons. crop. rot.</b>	slight-moderate	1-6	
<b>Waste utilization</b>	na	1-6	
<b>Irrig.Water mgt. (5)</b>	moderate	1-6	
<b>Tailwater rec. (5)</b>	slight	1-6	
<b>Irrig. system (5)</b>	na	1-6	
<b>Struct. water cont.</b>	slight	1-6	
<b>Water &amp; sed. basin</b>	moderate-substantial	1,2,5,6	
<b>Sediment basin</b>	substantial	1,2,5,6	
<b>Irrig. leveling (5)</b>	slight	1-6	
<b>Field border</b>	slight-moderate	1, 2, 5, 6(6)	
<b>Cover crop</b>	slight-moderate	1-6	
<b>Deep Tillage</b>	slight-moderate	1-6	
<b>Filter strips/buffers</b>	substantial	1, 2, 4-6(6)	
<b>Diversion</b>	medium	1,2,5,6	

**PROBLEM:** Sediment in a water body can smother organisms, interfere with photosynthesis by reducing light penetration, and may fill in waterways, hindering navigation and increasing flooding. Sediment particles often carry nutrients, pesticides, and other organic compounds into water bodies. Sediments can be resuspended in a water column and act as an uncontrolled source of pollution.

**PROCESSES:** Soil movement in water.

**CAUSES:** Precipitation on unprotected soil, flowing runoff water, and irrigation water applied at erosive rates.

1. There are many other practices not listed in this table which may be considered for installation for a specific purpose or as a part of a total resource management system which may increase or decrease loading or have little or no effects on water quality on a site-specific basis. An on-site analysis should be a consideration in evaluating the effect of a practice not listed.
2. This list is not ranked in an order, which would indicate preference in installation.
3. 1 = cotton, 2 = soybeans, 3 = sugarcane, 4 = rice, 5 = corn, 6 = truck crops.
4. An on-site evaluation should be conducted to determine if conditions exist which would result in unfavorable effects if the practice was installed.
5. Irrigated fields.
6. Fields not artificially drained.

**CROPLAND BEST MANAGEMENT PRACTICES (1) - Pesticide Concerns in Surface Water**

Favorable BMPs (2)	Favorable BMPs for: Soluble P/Adsorbed P	Crops(3)	Practices Which May Be Unfavorable (4)
<b>Pest management</b>	Sub Substantial	1-6	Land clearing
<b>Irrig.Water mgt. (5)</b>	Slight Substantial	1-6	Surface drainage(6)
<b>Tailwater rec. (5)</b>	slight moderate	1-6	Subsurface drain (6)
<b>Land leveling (5)</b>	slight moderate	1-6	
<b>Irrig. system (5)</b>	slight substantial	1-6	
<b>Struct. water cont.</b>	na na	1-6	
<b>Field border</b>	slight moderate	1-6(9)	
<b>Cover crop</b>	slight moderate	1-6	
<b>Deep Tillage</b>	slight substantial	1-6	
<b>Cons. crop. rot.</b>	slight moderate	1-6	
<b>Mulch till</b>	mod substantial	1, 2, 4-6	
<b>No till</b>	mod substantial	1, 2, 4-6	
<b>Ridge Till</b>	mod substantial	1-6	
<b>Crop residue, Seasonal</b>	slight moderate	1-6	
<b>Grade stab. struct.</b>	na na	1-6	
<b>Water &amp; sed. basin</b>	slight moderate	1,2,5,6	
<b>Terrace</b>	slight substantial	1,2,5,6	
<b>Sediment basin</b>	slight moderate	1,2,5,6	
<b>Filter strip/buffers</b>	slight substantial	1-6(9)	
<b>Contour farming</b>	slight moderate	1,2,5,6	
<b>Strip-cropping</b>	slight moderate	1,2,5,6	
<b>Diversion</b>	slight slight	1,2,5,6	
<b>Channel vegetation</b>	na na	1-6 (7)	
<b>Grassed waterway</b>	slight moderate	1-6 (7)	

PROBLEM: Pesticides by their nature are toxic substances. Many are highly toxic to fish, other aquatic fauna, and warm-blooded animals. Some persist in the aquatic environment for long periods of time so that even at very low level concentrations, they are a serious environmental concern in runoff water.

PROCESSES: Runoff of soluble pesticides in water and movement of pesticides combined with soil and organic matter from site.



CAUSES: Excess pesticide, applied pesticides with affinity for soil and organic matter, persistent pesticides, runoff water and interflow, excess irrigation water, improper pesticide application or irrigation timing, and improper mixing and handling of pesticides and pesticide containers.

1. There are many other practices not listed in this table which may be considered for installation for a specific purpose or as a part of a total resource management system which may increase or decrease loading or have little or no effect on water quality on a site-specific basis. An on-site analysis should be a consideration in evaluating the effect of a practice not listed.
2. This list is not ranked in an order, which would indicate preference in installation.
3. 1 = cotton, 2 = soybeans, 3 = sugarcane, 4 = rice, 5 = corn, 6 = truck crops.
4. An on-site evaluation should be conducted to determine if conditions exist which would result in unfavorable effects if the practice was installed.
5. Irrigated fields.
6. Where water table control or regulating water in drainage systems is not applied.
7. Chemical maintenance of vegetation may adversely affect the quality of runoff water.
8. Where drainage practices already exist.
9. Fields not artificially drained.

**CROPLAND BEST MANAGEMENT PRACTICES (1) - Nutrient Concerns in Surface Water**

Favorable BMPs (2)	Favorable BMPs for: Soluble N/Adsorbed N	Crops(3)	Practices Which May Be Unfavorable (4)
<b>Nutrient Mgt.</b>	substantial	1-6	Land clearing
<b>Waste utilization</b>	slight moderate	1-6	Surface drainage(6)
<b>Irrig.Water mgt. (5)</b>	Slight substantial	1-6	Subsurface drain (6)
<b>Tailwater rec. (5)</b>	slight moderate	1-6	
<b>Land leveling (5)</b>	slight moderate	1-6	
<b>Irrig. system (5)</b>	slight substantial	1-6	
<b>Struct. water cont.</b>	na na	1-6	
<b>Field border</b>	slight moderate	1-6(8)	
<b>Cover crop</b>	slight moderate	1-6	
<b>Deep tillage</b>	slight substantial	1-6	
<b>Cons. crop. rot.</b>	slight moderate	1-6	
<b>Mulch till</b>	slight moderate	1, 2, 4-6	
<b>No till</b>	slight slight	1, 2, 4-6	
<b>Ridge till</b>	slight slight	1-6	
<b>Crop residue, Seasonal</b>	slight slight	1-6	
<b>Grade stab. struct.</b>	na na	1-6	
<b>Water &amp; sed. basin</b>	slight moderate	1,2,5,6	
<b>Terrace</b>	slight moderate	1,2,5,6	
<b>Sediment basin</b>	substantial	1,2,5,6	
<b>Filter strips/buffers</b>	substantial	1-6(8)	
<b>Contour farming</b>	slight substantial	1,2,5,6	
<b>Strip-cropping</b>	Slight substantial	1,2,5,6	
<b>Diversion</b>	na na	1,2,5,6	
<b>Channel vegetation</b>	na na	1-6 (7)	
<b>Grassed waterway</b>	slight moderate	1-6 (7)	

**PROBLEM:** Excess nitrogen and phosphorus in a water body causes excessive plant and alga growth, an imbalance of natural nutrient cycles, and a decline in the number of desirable fish species. High nitrate levels can be hazardous to warm-blooded animals under conditions that are favorable to reduction to nitrite.

**PROCESSES:** Runoff of soluble nitrogen and phosphorus in water and movement of nitrogen and phosphorus combined with soil and organic matter from site.

**CAUSES:** Excess amounts of surface-applied nitrogen and phosphorus, runoff water and interflow, improperly managed irrigation systems, and erosion of soil and organic wastes.

1. There are many other practices not listed in this table which may be considered for installation for a specific purpose or as a part of a total resource management system which may increase or decrease loading or have little or no effects on water quality on a site-specific basis. An on-site analysis should be a consideration in evaluating the effect of a practice not listed.
2. This list is not ranked in an order, which would indicate preference in installation.
3. 1 = cotton, 2 = soybeans, 3 = sugarcane, 4 = rice, 5 = corn, 6 = truck crops.
4. An on-site evaluation should be conducted to determine if conditions exist which would result in unfavorable effects if the practice was installed.
5. Irrigated fields.
6. Where water table control or regulating water in drainage systems is not applied.
7. Chemical maintenance of vegetation may adversely affect the quality of runoff water.
8. Fields not artificially drained.
9. Where drainage practices already exist.

**CROPLAND BEST MANAGEMENT PRACTICES (1) - Minerals or Salinity Concerns in Surface Water**

<b>Favorable BMPs (2)</b>	<b>Effectiveness of Favorable BMPs</b>	<b>Crops(3)</b>	<b>Practices Which May Be Unfavorable (4)</b>
<b>Irrig. Water mgt. (5)</b>	slight-moderate	1-6	Land clearing
<b>Tailwater rec. (5)</b>	slight	1-6	Surface drainage(6)
<b>Water convey. (5)</b>	slight	1-6	Subsurface drain (6)
<b>Land leveling (5)</b>	neutral	1-6	
<b>Irrig. system (5)</b>	slight-substantial	1-6	
<b>Deep Tillage</b>	slight-moderate	1-6	
<b>Cons. crop. rot.</b>	slight-moderate	1-6	
<b>Waste utilization</b>	slight-moderate	1-6	

**PROBLEM:** Excessive concentrations of salts/minerals in surface waters can render the waters unfit for human and animal consumption and impair the growth of plants. It can also reduce or restrict the water's value for industrial use, irrigation and for propagation of fish and wildlife. The toxic effect of certain chemicals can be enhanced in saline waters, and the saturation levels of dissolved oxygen decrease with increasing salinity. Excessive salts can adversely alter the permeability of soils. The U.S. Public Health Service has established the maximum allowable concentrations of chlorides and sulfates in water for human consumption at 250 mg/l each. Excessive salt intake can produce minor to serious effects.

**PROCESSES:** Natural processes and movement (surface runoff and interflow) of dissolved minerals and salts from soil and organic waste by irrigation or storm water.

**CAUSES:** High content of minerals and salt concentration in soil and underlying geology, excess irrigation water, high content of minerals and salt concentration in irrigation water, and over-application of waste with high salt content.

1. There are many other practices not listed in this table which may be considered for installation for a specific purpose or as a part of a total resource management system which may increase or decrease loading or have little or no effects on water quality on a site-specific basis. An on-site analysis should be a consideration in evaluating the effect of a practice not listed.
2. This list is not ranked in an order, which would indicate preference in installation.
3. 1 = cotton, 2 = soybeans, 3 = sugarcane, 4 = rice, 5 = corn, 6 = truck crops.
4. An on-site evaluation should be conducted to determine if conditions exist which would result in unfavorable effects if the practice was installed.
5. Irrigated fields.
6. Where water table control or regulating water in drainage systems is not applied.
7. Where drainage practices already exist.

**CROPLAND BEST MANAGEMENT PRACTICES (1) - Organic Matter & Bacteria Concerns in Surface Water**

<b>Favorable BMPs (2)</b>	<b>Effectiveness of Favorable BMPs for: Oxy. Demand/Bacteria</b>	<b>Crops(3)</b>	<b>Practices Which May Be Unfavorable (4)</b>
<b>Waste utilization</b>	Slight neutral	1-6	Land clearing
<b>Struct. water cont.</b>	na na	1-6	Surface drainage(6)
<b>Field border</b>	mod slight	1, 2, 5, 6(7)	Subsurface drain (6)
<b>Filter strips/buffers</b>	sub slight	1, 2, 5, 6(7)	
<b>Terrace</b>	mod moderate	1,2,5,6	
<b>Contour farming</b>	mod slight	1,2,5,6	
<b>Strip-cropping</b>	mod slight	1,2,5,6	
<b>Water &amp; sed. basin</b>	mod slight	1,2,5,6	
<b>Sediment basin sub</b>	mod	1,2,5,6	
<b>Diversion</b>	neutral slight	1,2,5,6	
<b>Irrig Water mgt. (5)</b>	slight substantial	1-6	
<b>Irrig. system (5)</b>	slight slight	1-6	
<b>Deep tillage</b>	slight slight	1-6	

**PROBLEM:** Animal waste and crop debris are the major organic pollutants resulting from agricultural activities. They place an oxygen demand on receiving waters during decomposition, which can result in stress or the death of fish and other aquatic species. Certain bacteria can cause disease in humans such as infectious hepatitis, typhoid fever, dysentery, and other forms of diarrhea.

**PROCESSES:** Movement of organic waste, bacteria, and organic matter in soil from the site and excess irrigation water.

**CAUSES:** Over-application of waste or irrigation water, application of waste on unsuitable sites, improper timing of waste or irrigation application, and storm runoff.

1. There are many other practices not listed in this table which may be considered for installation for a specific purpose or as a part of a total resource management system which may increase or decrease loading or have little or no effects on water quality on a site-specific basis. An on-site analysis should be a consideration in evaluating the effect of a practice not listed.
2. This list is not ranked in an order, which would indicate preference in installation.
3. 1 = cotton, 2 = soybeans, 3 = sugarcane, 4 = rice, 5 = corn, 6 = truck crops.
4. An on-site evaluation should be conducted to determine if conditions exist which would result in unfavorable effects if the practice was installed.
5. Irrigated fields.
6. Where water table control or regulating water in drainage systems is not applied.
7. Fields not artificially drained.
8. Where drainage practices already exist.

**BEST MANAGEMENT PRACTICES (1) - Sediment Concerns in Surface Water**

<b>Favorable BMPs (2)</b>	<b>Effectiveness of Favorable BMPs</b>	<b>Practices Which May Be Unfavorable (3)</b>
Pasture & hayland planting	substantial	Land clearing
Irrigation water management (4)	substantial	
Critical area planting	substantial	
Use Exclusion (5)	na	
Fencing (6)	neutral	
Prescribed Grazing	substantial	
Mechanical Forage Harvest	moderate	
Irrigation water conveyance (4)	moderate	
Appropriate irrigation system (4)	moderate	
Filter strip/buffer	moderate	
Pond (6)	slight-substantial	
Well (6)	na	
Spring development (6)	slight	
Pipeline (6)	na	
Brush management	slight	

**PROBLEM:** Sediment in a water body can smother benthic organisms, interfere with photosynthesis by reducing light penetration, and may fill in waterways, hindering navigation and increasing flooding. Sediment particles often carry nutrients and pesticides and other organic compounds into water bodies. Sediments can be resuspended in a water column and act as an uncontrolled source of pollution.

**PROCESS:** Movement of sediment from site.

**CAUSES:** Concentration of livestock in or near watercourses leading to instability and overuse of vegetation.

1. There are many other practices not listed in this table which may be considered for installation for a specific purpose or as a part of a total resource management system which may increase or decrease loading or have little or no effects on water quality on a site-specific basis. An on-site analysis should be a consideration in evaluating the effect of a practice not listed.
2. This list is not ranked in an order, which would indicate preference in installation.
3. An on-site evaluation should be conducted to determine if conditions exist which would result in unfavorable effects if the practice was installed.
4. Irrigated fields.
5. To exclude livestock from streams.
6. To distribute grazing.

**PASTURELAND BEST MANAGEMENT PRACTICES (1) - Nutrient Concerns in Surface Water**

<b>Favorable BMPs (2)</b>	<b>Effectiveness of Favorable BMPs for: Soluble N./ Adsorbed N.</b>	<b>Practices Which May Be Unfavorable (3)</b>
<b>Nutrient management</b>	substantial	Subsurface drain (4)
<b>Waste Utilization</b>	substantial	Subsurface drain (4)
<b>Irrigation water management (5)</b>	substantial	
<b>Pasture &amp; hayland planting</b>	substantial	
<b>Use Exclusion (6)</b>	neutral	
<b>Pond</b>	slight-moderate	
<b>Buffers</b>	slight-substantial	
<b>Fencing (7)</b>	neutral	
<b>Well (7)</b>	na	
<b>Pipeline (7)</b>	na	
<b>Prescribed Grazing</b>	moderate	
<b>Forage harvest mgt.</b>	slight-moderate	
<b>Spring development</b>	na	

**PROBLEM:** Excess nitrogen and phosphorus in a water body causes excessive plant and algae growth, an imbalance of natural nutrient cycles, and a decline in the number of desirable fish species. High nitrate levels can be hazardous to warm-blooded animals under conditions that are favorable to reduction to nitrite.

**PROCESSES:** Runoff of soluble nitrogen and phosphorus in water and movement of nitrogen and phosphorus combined with soil and organic matter from site.

**CAUSES:** Excess surface applied nitrogen and phosphorus, runoff water and interflow, erosion of soil and organic waste, cattle congregating in or near streams, and excess irrigation water application beyond root zone.

1. There are many other practices not listed in this table which may be considered for installation for a specific purpose or as a part of a total resource management system which may increase or decrease loading or have little or no effects on water quality on a site-specific basis. An on-site analysis should be a consideration in evaluating the effect of a practice not listed.
2. This list is not ranked in an order, which would indicate preference in installation.
3. An on-site evaluation should be conducted to determine if conditions exist which would result in unfavorable effects if the practice was installed.
4. Where water table control or regulating water in drainage systems is not applied.
5. Irrigated fields.
6. To exclude livestock from streams.
7. To distribute grazing.

**PASTURELAND BEST MANAGEMENT PRACTICES (1) - Pesticide Concerns in Surface Water**

<b>Favorable BMPs (2)</b>	<b>Effectiveness of Favorable BMPs for: Soluble P./ Adsorbed P.</b>	<b>Practices Which May Be Unfavorable (3)</b>
<b>Pasture &amp; hayland planting</b>	substantial	Subsurface drain (4)
<b>Irrigation water management (5)</b>	substantial	Surface drainage (4)
<b>Prescribed grazing</b>	moderate	
<b>Forage harvest management</b>	slight-moderate	
<b>Filter strips/buffers</b>	moderate	
<b>Pest Management</b>	substantial	

**PROBLEM:** Pesticides by their nature are toxic substances. Many are highly toxic to fish, other aquatic fauna, and warm-blooded animals. Some persist in the aquatic environment for long periods of time so that even at very low concentrations, they are a serious environmental concern in runoff water.

**PROCESSES:** Runoff of soluble pesticides in water and movement of pesticides combined with soil and organic matter from site.

**CAUSES:** Excess pesticide, applied pesticides with affinity for soil and organic matter, persistent pesticides, runoff water and interflow, improper pesticide application and/or timing, improper mixing and handling of pesticides and pesticide containers, and excess irrigation water application beyond root zone.

1. There are many other practices not listed in this table which may be considered for installation for a specific purpose or as a part of a total resource management system which may increase or decrease loading or have little or no effects on water quality on a site-specific basis. An on-site analysis should be a consideration in evaluating the effect of a practice not listed.
2. This list is not ranked in an order, which would indicate preference in installation.
3. An on-site evaluation should be conducted to determine if conditions exist which would result in unfavorable effects if the practice was installed.
4. Where water table control or regulating water in drainage systems is not applied.
5. Irrigated fields.



**PASTURELAND BEST MANAGEMENT PRACTICES (1) - Organic Matter & Bacteria Concerns in Surface Water**

<b>Favorable BMPs (2)</b>	<b>Effectiveness of Favorable BMPs for: Oxygen Demand/ Bacteria</b>	<b>Practices Which May Be Unfavorable (3)</b>
<b>Waste utilization</b>	mod neutral	Surface drainage (4)
<b>Pond</b>	slight sl. worsening	Subsurface drain (4)
<b>Nutrient management</b>	Sub slight	
<b>Use Exclusion (5)</b>	slight-moderate	
<b>Fencing (6)</b>	neutral	
<b>Filter strip/buffers</b>	sub. slight	
<b>Prescribed grazing</b>	slight	
<b>Forage harvest mgt.</b>	slight	
<b>Pasture and hayland planting</b>	slight	
<b>Well (6)</b>	na	
<b>Pipeline (6)</b>	na	
<b>Spring development (6)</b>	na slight	
<b>Irrigation water management (7)</b>	slight substantial	

**PROBLEM:** Animal waste and plant debris is the major organic pollutant from pastureland. They place an oxygen demand on receiving waters during decomposition, which can result in stress or the death of fish and other aquatic species. Certain bacteria can cause disease in humans such as infectious hepatitis, typhoid fever, dysentery, and other forms of diarrhea.

**PROCESS:** Movement of organic waste, bacteria, and organic matter in soil and water from the site.

**CAUSES:** Over application of waste, application of waste on unsuitable sites, improper timing of waste application, storm runoff, and concentration of livestock in or near watercourses.

1. There are many other practices not listed in this table which may be considered for installation for a specific purpose or as a part of a total resource management system which may increase or decrease loading or have little or no effects on water quality on a site-specific basis. An on-site analysis should be a consideration in evaluating the effect of a practice not listed.
2. This list is not ranked in an order, which would indicate preference in installation.
3. An on-site evaluation should be conducted to determine if conditions exist which would result in unfavorable effects if the practice was installed.
4. Where water table control or regulating water in drainage systems is not applied.
5. To exclude livestock from streams.
6. To distribute grazing.
7. Irrigated fields.

**PASTURELAND BEST MANAGEMENT PRACTICES (1) - Minerals or Salinity Concerns in Surface Water**

<b>Favorable BMPs (2)</b>	<b>Effectiveness of Favorable BMPs</b>	<b>Practices Which May Be Unfavorable (3)</b>
<b>Irrigation water management (4)</b>	slight-moderate	Land clearing
<b>Nutrient management</b>	slight	Subsurface drain (5)
<b>Irrigation water conveyance (4)</b>	slight	Surface drainage (5)
<b>Irrigation system (4)</b>	neutral to moderate	
<b>Forage harvest management</b>	slight	
<b>Prescribed grazing</b>	slight-moderate	
<b>Waste utilization</b>	slight-moderate	

**PROBLEM:** Excessive concentrations of salts/minerals in surface waters can render the waters unfit for human and animal consumption and impair the growth of plants. It can also reduce or restrict the water's value for industrial use, irrigation and for propagation of fish and wildlife. The toxic effect of certain chemicals can be enhanced in saline waters. Excessive salts can adversely alter the permeability of soils. The U.S. Public Health Service has established the maximum allowable concentrations of chlorides and sulfates in water for human consumption at 250 mg/l each. Excessive salt intake can produce minor to serious effects.

**PROCESSES:** Natural processes, movement of organic waste, sheet flow from surface runoff and interflow from ground water as influenced by human activities.

**CAUSES:** High content of minerals and salt concentration in soil and underlying geology, over application of waste with high salinity content, movement of minerals and salinity in soil from the site by precipitation runoff and interflow (saline seeps), high content of minerals and salt concentration in irrigation water, and excess irrigation water.

1. There are many other practices not listed in this table which may be considered for installation for a specific purpose or as a part of a total resource management system which may increase or decrease loading or have little or no effects on water quality on a site-specific basis. An on-site analysis should be a consideration in evaluating the effect of a practice not listed.
2. This list is not ranked in an order, which would indicate preference in installation.
3. An on-site evaluation should be conducted to determine if conditions exist which would result in unfavorable effects if the practice was installed.
4. Irrigated fields.
5. Where water table control or regulating water in drainage systems is not applied.

**PASTURELAND BEST MANAGEMENT PRACTICES (1) - Minerals or Salinity Concerns in Ground Water**

<b>Favorable BMPs (2)</b>	<b>Effectiveness of Favorable BMPs</b>	<b>Practices Which May Be Unfavorable (3)</b>
<b>Irrigation water management (4)</b>	slight-substantial	Irr. field ditch (4)
<b>Surface drainage</b>	slight-moderate	Irr. canal/lateral (4)
<b>Subsurface drain</b>	slight-moderate	Soil salinity mgt
		Toxic salt reduction
<b>Irrigation conveyance (4)</b>	slight	
<b>Irrigation system (4)</b>	slight-moderate	
<b>Nutrient management</b>	slight	
<b>Waste utilization</b>	slight-moderate	
<b>Prescribed grazing</b>	slight	
<b>Forage harvest mgt.</b>	slight	
<b>Pasture/hayland planting</b>	slight	
<b>Fencing</b>	neutral	
<b>Pond</b>	na	
<b>Spring development</b>	na	
<b>Pipeline</b>	na	

**PROBLEM:** Excessive concentrations of salts/minerals can render ground water unfit for human and animal consumption. It can reduce or restrict the water's value for industrial and municipal use and irrigation. The toxic effect of certain chemicals can be enhanced in saline waters, and the saturation levels of dissolved oxygen decreases with increasing salinity. The U. S. Public Health Service has established the maximum allowable concentrations of chlorides and sulfates in water for human consumption at 250 mg/l each. Excessive salt intake can produce minor to serious effects.

**PROCESSES:** Natural processes and leaching of minerals or salt concentrations.

**CAUSES:** Naturally occurring, excess water moving downward from human activity of concentrating water or changing evapotranspiration, and irrigation water contains high concentration of dissolved solids.

1. There are many other practices not listed in this table which may be considered for installation for a specific purpose or as a part of a total resource management system which may increase or decrease loading or have little or no effects on water quality on a site-specific basis. An on-site analysis should be a consideration in evaluating the effect of a practice not listed.
2. This list is not ranked in an order, which would indicate preference in installation.
3. An on-site evaluation should be conducted to determine if conditions exist which would result in unfavorable effects if the practice was installed.
4. Irrigated fields.

## **Appendix E**

### **Commodity Manual Best Management Practices**

### **Beef Cattle Best Management Practices**

<http://www.lsuagcenter.com/NR/rdonlyres/55BE3063-E11C-483E-BF86-40DB68705270/87569/pub2884beefbmppubLOWRES.pdf>

### **Agronomic Crops Best Management Practices**

<http://www.lsuagcenter.com/NR/rdonlyres/CB67F3CD-CE73-4C39-B6E4-52F772F970CF/84012/pub2807AgronomicCropsBMPLOWRES.pdf>

### **Sugarcane Best Management Practices**

[http://www.lsuagcenter.com/NR/rdonlyres/27AA7189-F3AC-4FEA-A51D-E5D8E2B16505/82493/pub2833\\_SugarcaneBMP.pdf](http://www.lsuagcenter.com/NR/rdonlyres/27AA7189-F3AC-4FEA-A51D-E5D8E2B16505/82493/pub2833_SugarcaneBMP.pdf)

Outreach efforts have been developed to address residential nonpoint source pollution. The La Yards and Neighborhoods Program was developed by the LSU AgCenter to encourage homeowners to create and maintain landscapes in ways that minimize environmental damage/impact through educational programs and outreach activities. This program can be offered to residents of the False River community. The program link as well as home source best management practice manuals are below:

<http://www.lsuagcenter.com/NR/rdonlyres/BC916876-1D8F-4F4D-83FC-F86A1BE5DDF4/57407/Pages17.pdf>

### **Home Source Best Management Practices**

<http://www.lsuagcenter.com/NR/rdonlyres/3A849060-4119-48B7-9771-A0DE16A6A623/39935/Pub2994NPSmanual2.pdf>